

OPERATING INSTRUCTIONS

EN

Translation of the Original

CENTERONE | -TWO | -THREE

Total pressure measuring and control unit

PFEIFFER  **VACUUM**



Dear Customer,

Thank you for choosing a Pfeiffer Vacuum product. Your new total pressure measuring and control unit should support you in your individual application with full performance and without malfunctions. The name Pfeiffer Vacuum stands for high-quality vacuum technology, a comprehensive and complete range of top-quality products and first-class service. From this extensive, practical experience we have gained a large volume of information that can contribute to efficient deployment and to your personal safety.

In the knowledge that our product must avoid consuming work output, we trust that our product can offer you a solution that supports you in the effective and trouble-free implementation of your individual application.

Please read these operating instructions before putting your product into operation for the first time. If you have any questions or suggestions, please feel free to contact info@pfeiffer-vacuum.de.

Further operating instructions from Pfeiffer Vacuum can be found in the [Download Center](#) on our website.

Disclaimer of liability

These operating instructions describe all models and variants of your product. Note that your product may not be equipped with all features described in this document. Pfeiffer Vacuum constantly adapts its products to the latest state of the art without prior notice. Please take into account that online operating instructions can deviate from the printed operating instructions supplied with your product.

Furthermore, Pfeiffer Vacuum assumes no responsibility or liability for damage resulting from the use of the product that contradicts its proper use or is explicitly defined as foreseeable misuse.

Copyright

This document is the intellectual property of Pfeiffer Vacuum and all contents of this document are protected by copyright. They may not be copied, altered, reproduced or published without the prior written permission of Pfeiffer Vacuum.

We reserve the right to make changes to the technical data and information in this document.



Table of contents

1	About this manual	7
1.1	Validity	7
	1.1.1 Related documents	7
	1.1.2 Variants	7
	1.1.3 Firmware versions	7
1.2	Target group	7
1.3	Conventions	8
	1.3.1 Instructions in the text	8
	1.3.2 Pictographs	8
	1.3.3 Stickers on the product	8
	1.3.4 Abbreviations	8
1.4	Trademarks	9
2	Safety	10
2.1	General safety instructions	10
2.2	Safety instructions	10
2.3	Safety precautions	14
2.4	Proper use	14
2.5	Foreseeable improper use	15
2.6	Responsibilities and warranty	15
2.7	Owner requirements	15
2.8	Personnel qualification	15
	2.8.1 Ensuring personnel qualification	16
	2.8.2 Personnel qualification for maintenance and repair	16
	2.8.3 Advanced training with Pfeiffer Vacuum	16
2.9	Operator requirements	16
3	Transportation and storage	17
4	Product description	18
4.1	Identifying the product	18
4.2	Scope of delivery	18
4.3	Design, construction	18
4.4	Display elements	20
4.5	Controls	22
4.6	Interfaces	22
	4.6.1 Mains power supply	22
	4.6.2 Ground terminal	23
	4.6.3 "CH" connection (channel)	23
	4.6.4 "CONTROL" connection (CenterOne)	24
	4.6.5 "CONTROL" connection (CenterTwo/CenterThree)	25
	4.6.6 "RELAY" connection (only CenterTwo/CenterThree)	25
	4.6.7 "USB" connection (type B)	26
	4.6.8 "USB" connection (type A)	26
	4.6.9 "Ethernet" (LAN) connection	27
5	Installation	28
5.1	Installing the device in a 19" rack	28
5.2	Installing the device in a switchboard	30
5.3	Using the device as a desktop device	31
6	Commissioning	32
6.1	Switch on the device	32
6.2	Updating the firmware	32
6.3	Configuring Ethernet	34
7	Operation	38

7.1	Basic operation	38
7.2	Operating modes	38
7.3	Measuring mode	38
7.4	Parameter mode	40
	7.4.1 Switching function parameters	43
	7.4.2 Gauge parameters	44
	7.4.3 Gauge control	46
	7.4.4 General parameters	48
	7.4.5 Test parameters	53
7.5	Data logger mode	55
7.6	Setup mode	57
8	Decommissioning	59
9	Maintenance	60
	9.1 Cleaning the device	60
	9.2 Replacing the battery	61
10	Malfunctions	62
11	Shipping	63
12	Disposal	64
13	Service solutions from Pfeiffer Vacuum	65
14	Ordering information	67
	14.1 Ordering parts	67
	14.2 Accessories	67
15	Technical data and dimensions	68
	15.1 Technical data	68
	15.2 Dimensions	72
16	Appendix	73
	16.1 Units of pressure	73
	16.2 Gas throughputs	73
	ETL Listed	74
	Declaration of conformity	75



List of tables

Tbl. 1:	Related documents	7
Tbl. 2:	Variants	7
Tbl. 3:	Abbreviations used	9
Tbl. 4:	Danger to life due to electric voltage	11
Tbl. 5:	Controls	22
Tbl. 6:	Switching functions	25
Tbl. 7:	Switching functions	26
Tbl. 8:	Status of the Ethernet connection	27
Tbl. 9:	Description of the controls	38
Tbl. 10:	Parameters of this group	43
Tbl. 11:	Examples for displays	43
Tbl. 12:	Upper and lower threshold values	43
Tbl. 13:	Parameters of this group	44
Tbl. 14:	Available parameters	45
Tbl. 15:	Parameters of this group	46
Tbl. 16:	Available parameters	47
Tbl. 17:	Switch-on type (S-ON)	47
Tbl. 18:	Switch-off type (S-OFF)	47
Tbl. 19:	Parameters of this group	48
Tbl. 20:	Available parameters	48
Tbl. 21:	Parameters of this group	53
Tbl. 22:	Parameters of this group	55
Tbl. 23:	Parameters of this group	57
Tbl. 24:	Malfunctions	62
Tbl. 25:	General	68
Tbl. 26:	Mains power supply	68
Tbl. 27:	Ambient conditions	68
Tbl. 28:	Gauge connections	69
Tbl. 29:	Gauge supply voltage	69
Tbl. 30:	Operation	69
Tbl. 31:	Measured values	69
Tbl. 32:	Switching functions	70
Tbl. 33:	Switching function relay	70
Tbl. 34:	Error signal (error)	70
Tbl. 35:	Error signal relay	70
Tbl. 36:	Gauge control	71
Tbl. 37:	Analog output	71
Tbl. 38:	Logger output	71
Tbl. 39:	USB interface (type A)	71
Tbl. 40:	USB interface (type B)	71
Tbl. 41:	Ethernet interface	72
Tbl. 42:	Units of pressure and their conversion	73
Tbl. 43:	Gas throughputs and their conversion	73

List of figures

Fig. 1:	Disconnect device in accordance with EN 61010-1	11
Fig. 2:	Front panel	19
Fig. 3:	Connections on the rear side	19
Fig. 4:	Display CenterOne	20
Fig. 5:	Display CenterTwo and CenterThree	20
Fig. 6:	Exponential illustration of the measurement channel measured value (examples)	20
Fig. 7:	Parameter or bar graph	21
Fig. 8:	Switch-points, parameter mode and input lock	21
Fig. 9:	Measurement channel status	21
Fig. 10:	Mains connection with IEC 320 C13 socket	22
Fig. 11:	Connections A and B on the measuring channels	23
Fig. 12:	Connection CH A (RJ-45 socket)	23
Fig. 13:	Connection CH B (D-Sub socket)	24
Fig. 14:	"CONTROL" connection (15-pole D-Sub plug)	24
Fig. 15:	"CONTROL" connection (9-pole D-Sub plug)	25
Fig. 16:	"RELAY" connection (25-pole D-Sub socket)	26
Fig. 17:	"USB" connection (type B)	26
Fig. 18:	"USB" connection (type A)	27
Fig. 19:	"Ethernet" (LAN) connection	27
Fig. 20:	Guide rails	28
Fig. 21:	Rack module adapter (2 height units, only CenterOne)	28
Fig. 22:	Rack module adapter (3 height units)	28
Fig. 23:	Adapter plate (only CenterOne with 3 height unit rack module adapter)	29
Fig. 24:	Installing the CenterOne	29
Fig. 25:	Install CenterTwo/CenterThree	29
Fig. 26:	Required control panel cut-out (CenterOne)	30
Fig. 27:	Required control panel cut-out (CenterTwo/CenterThree)	30
Fig. 28:	Fastening the rubber feet and rubber strip	31
Fig. 29:	USB Update Tool	33
Fig. 30:	Ethernet Configuration Tool	36
Fig. 31:	Changing the measurement channel (only CenterTwo and CenterThree)	39
Fig. 32:	Switching gauges on and off	39
Fig. 33:	Switching emission on and off	39
Fig. 34:	Measuring range	40
Fig. 35:	Identifying the gauge	40
Fig. 36:	Change from measuring mode to parameter mode	40
Fig. 37:	Change parameters	41
Fig. 38:	Read/write parameter groups and parameters (CenterOne)	41
Fig. 39:	Read/write parameter groups and parameters (CenterTwo/CenterThree)	42
Fig. 40:	Switching functions and threshold values	44
Fig. 41:	Fast, normal and slow (from left to right)	45
Fig. 42:	Press the arrow keys simultaneously > 2 seconds	52
Fig. 43:	Program memory test	54
Fig. 44:	Parameter memory test	54
Fig. 45:	Display test	54
Fig. 46:	Test of relays in the device	55
Fig. 47:	Start/stop measured data recording	56
Fig. 48:	Delete files	56
Fig. 49:	Formatting the USB memory stick	57
Fig. 50:	Delete parameter files from the USB memory stick	58
Fig. 51:	Dimensions CenterOne (in mm)	72
Fig. 52:	Dimensions CenterTwo and CenterThree (in mm)	72



1 About this manual



IMPORTANT

Read carefully before use.
Keep the manual for future consultation.

1.1 Validity

This document describes the function of the products listed in the following and provides the most important information for safe use. The description is written in accordance with the valid directives. The information in this document refers to the current development status of the products. The document retains its validity assuming that the customer does not make any changes to the product.

1.1.1 Related documents

Designation	Document
“Measuring and control unit” communication instructions CenterOne CenterTwo CenterThree	BG 5045
“Gauges/Transmitters” operating manuals CenterLine gauge	(depending on the device used)
Declaration of conformity	(Part of this document)

Tbl. 1: Related documents

1.1.2 Variants

This document applies to products with the following part numbers:

Part number	Designation
PT G28 310	CenterOne (single-channel controller)
PT G28 320	CenterTwo (dual-channel controller)
PT G28 330	CenterThree (triple-channel controller)

Tbl. 2: Variants

Information that relates to only one of the devices is indicated as such. Any unlabeled figures show the CenterThree, however, they also apply to the CenterOne and CenterTwo.

The part number is found on the rating plate of the product.

Pfeiffer Vacuum reserves the right to make technical changes without prior notification.

The figures in this document are not to scale (Dimensions in mm).

1.1.3 Firmware versions

This document is based on firmware version **V1.06**.

Older firmware versions do not have the full functionality described in this operating manual.

Checking the firmware version

1. If the device is not functioning as it did before, check whether the correct firmware version is installed.
2. If you have any questions about the firmware, contact Pfeiffer Vacuum.

1.2 Target group

These operating instructions are aimed at all persons performing the following activities on the product:

- Transportation
- Setup (Installation)
- Usage and operation

- Decommissioning
- Maintenance and cleaning
- Storage or disposal

The work described in this document is only permitted to be performed by persons with the appropriate technical qualifications (expert personnel) or who have received the relevant training from Pfeiffer Vacuum.

1.3 Conventions

1.3.1 Instructions in the text

Usage instructions in the document follow a general structure that is complete in itself. The required action is indicated by an individual step or multi-part action steps.

Individual action step

A horizontal, solid triangle indicates the only step in an action.

- ▶ This is an individual action step.

Sequence of multi-part action steps

The numerical list indicates an action with multiple necessary steps.

1. Step 1
2. Step 2
3. ...

1.3.2 Pictographs

Pictographs used in the document indicate useful information.



Note



Tip

1.3.3 Stickers on the product

This section describes all the stickers on the product along with their meaning.

	<p>Rating plate</p> <p>The rating plate is located on the right-hand side of the device.</p>
--	---

1.3.4 Abbreviations

Abbreviation	Explanation
A/D	Analog/Digital
F.S.	Full Scale (limit value)
FSR	Full Scale Range (upper range value)
RNE-EXT	Range Extension



Abbreviation	Explanation
SP	Switch-point (setpoint)
UART	Universal Asynchronous Receiver Transmitter (Electronic circuit used to implement serial interfaces)

Tbl. 3: Abbreviations used

1.4 Trademarks

- CenterLine® is a trademark of Pfeiffer Vacuum GmbH.

2 Safety

2.1 General safety instructions

This document includes the following 4 risk levels and 1 information level.

⚠ DANGER

Imminent danger
Indicates a hazardous situation which, if not avoided, will result in death or serious injury.

- ▶ Instructions on avoiding the hazardous situation

⚠ WARNING

Possibly imminent danger
Indicates a hazardous situation which, if not avoided, could result in death or serious injury.

- ▶ Instructions on avoiding the hazardous situation

⚠ CAUTION

Possibly imminent danger
Indicates a hazardous situation which, if not avoided, could result in minor or moderate injury.

- ▶ Instructions on avoiding the hazardous situation

NOTICE

Danger of property damage
Notice is used to address practices not related to physical injury.

- ▶ Instructions on avoiding property damage

i Notes, tips or examples indicate important information on the product or on this document.

2.2 Safety instructions

i **Safety instructions according to product's life stages**
All safety instructions in this document are based on the results of a risk assessment. Pfeiffer Vacuum has taken into account all the relevant life stages of the product.





Danger to life due to electric voltage

⚠ DANGER

Danger to life due to electric voltage

High voltages are present inside the device. When touching parts that are live, there is a risk of death. If there is visible damage, there is a risk of death when commissioning the device.

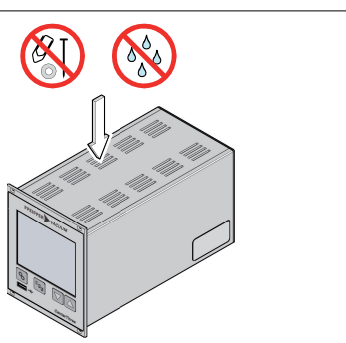
- ▶ Work on the open device must only be carried out by trained specialist personnel.
- ▶ Before carrying out any installation and maintenance work, switch the device off and disconnect it from the current supply.
 - After switching off, wait about 60 seconds and then disconnect all cables (power cable at the end).
- ▶ Never open the device with the current supply connected.
- ▶ Secure the current supply against unauthorized or unintentional reactivation.
- ▶ Do not insert any objects into the vent openings.
- ▶ Never open an external power supply unit.
- ▶ Never operate an open or defective device.
- ▶ Secure a defective device against accidental operation.
- ▶ Protect the device against moisture.

	 <p>Do not insert any objects into the vent openings.</p>
	 <p>Protect the device against moisture.</p>

Tbl. 4: Danger to life due to electric voltage

Disconnect device

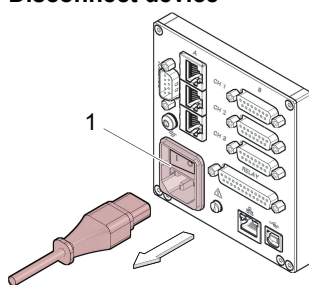

Fig. 1: Disconnect device in accordance with EN 61010-1

1 Disconnect device

The disconnect device must be clearly recognizable by the user and within easy reach.

Risks during transport

NOTICE

Damage caused by incorrect transportation

Transportation in unsuitable packaging, or failure to install all transport locks, can damage the product.

- ▶ Comply with the instructions for safe transportation.

Risks during storage

NOTICE

Damage caused by improper storage

Improper storage will lead to damage to the product.

Static charging, moisture, etc. lead to defects on the electronic components.

- ▶ Comply with the instructions for safe storage.

Risks during installation

⚠ DANGER

Danger to life from electric shock

Inadequate or incorrect grounding of the unit leads to contact-sensitive voltage on the housing. When making contact, increased leakage currents will cause a life-threatening electric shock.

- ▶ Before the installation, check that the connection leads are voltage-free.
- ▶ Conduct the electrical connection in accordance with locally applicable regulations.
- ▶ Make sure that the local mains voltage and frequency match rating plate specifications.
- ▶ Make sure that the mains cable and extension cable meet the requirements for double isolation between input voltage and output voltage, in accordance with IEC 61010 and IEC 60950.
- ▶ Use only a 3-pin mains cable and extension cable with properly connected protective earthing (earthed conductor).
- ▶ Plug the mains plug into a socket with earthing contact only.
- ▶ Always connect the mains cable prior to all other cables, to ensure continuous protective earthing.

⚠ DANGER

Danger to life from electric shock

The internal earthed conductor is fastened to the housing by a screw. A device without an earthed conductor attached can be life-threatening in the event of a malfunction.

- ▶ Do not rotate or loosen the screw on the internal earthed conductor.

NOTICE

Damage caused by penetrating moisture

Penetrating moisture, e.g. through condensation or dripping water, damages the device.

- ▶ Protect the device against moisture penetrating.
- ▶ Only operate the device in a clean and dry environment.
- ▶ Operate the device away from fluids and humidity sources.
- ▶ Take special precautions if there is a risk of dripping water.
- ▶ Do not switch on the device if fluid has penetrated into it, instead contact the Pfeiffer Vacuum Service Center.

NOTICE

Damage caused by overheating

The ambient temperature must not exceed the permissible operating temperature of the device.

- ▶ Make sure there is unobstructed circulation of air when installing the device.
- ▶ Make sure that air can enter and exit through the ventilation openings without obstruction.
- ▶ Do not cover the ventilation openings.
- ▶ Periodically check and clean the installed air filter.

NOTICE

Loss of control cabinet protection class

As a built-in unit, the device can negate the required protection class (protection against foreign matter and water) of control cabinets according to IEC 60204-1, for example.

- ▶ Take suitable measures to reestablish the required protection class.



NOTICE**Damage caused by connection from CH A and CH B**

Connecting CH A and CH B of a measurement channel at the same time damages the connected gauges.

- ▶ Always only connect CH A or CH B.

Risks during operation**⚠ DANGER****Electric shocks due to moisture penetrating into the device**

Moisture that has penetrated into the device results in personal injury through electric shocks.

- ▶ Only operate the device in a dry environment.
- ▶ Operate the device away from fluids and humidity sources.
- ▶ Do not switch on the device if fluid has penetrated into it, instead contact Pfeiffer Vacuum Service.
- ▶ Always disconnect the current supply before cleaning the device.

⚠ DANGER**Danger to life due to dangerous contact voltage**

Voltages above 30 V (AC) or 60 V (DC) are considered dangerous in accordance with IEC 61010. If you come into contact with dangerous contact voltage, this can result in injury through electric shocks or even death.

- ▶ Only apply protected extra-low voltage (PELV).

NOTICE**Unintentional results with controller connected**

Switch relay not dependent on pressure. Values below the intended measuring range, or starting the test program, can result in unintentional results at the connected controller, if the relay switches.

- ▶ Unplug the connected measuring and control cable.
- ▶ Prevent triggering of incorrect control commands or messages.

Risks during maintenance**⚠ WARNING****Health hazard through poisoning from toxic contaminated components or devices**

Toxic process media result in contamination of devices or parts of them. During maintenance work, there is a risk to health from contact with these poisonous substances. Illegal disposal of toxic substances causes environmental damage.

- ▶ Take suitable safety precautions and prevent health hazards or environmental pollution by toxic process media.
- ▶ Decontaminate affected parts before carrying out maintenance work.
- ▶ Wear protective equipment.

⚠ WARNING**Health hazards due to cleaning agent**

The cleaning agents used cause health hazards.

- ▶ When handling cleaning agents, observe the applicable regulations.
- ▶ Adhere to safety measures regarding handling and disposal of cleaning agents.
- ▶ Be aware of potential reactions with product materials.



NOTICE

Damage caused by unsuitable cleaning agents

Unsuitable cleaning agents damage the product.

- ▶ Do not use solvents as they attack the surface.
- ▶ Do not use any aggressive or abrasive cleaning agents.

Risks when shipping

⚠ WARNING

Risk of poisoning from contaminated products

Where products that contain harmful substances are shipped for maintenance or repair purposes, the safety of service personnel is at risk.

- ▶ Comply with the instructions for safe shipping.

Risks during disposal

⚠ CAUTION

Health hazard caused by environmentally hazardous substances

Products, operating fluid, electric components, calibration gas residues (for example from test leaks) or similar pose health hazards.

- ▶ Dispose of the environmentally hazardous substances in accordance with local regulations.
- ▶ Dispose of calibration gas and test leaks in accordance with local regulations.

2.3 Safety precautions

The product is designed according to the latest technology and recognized safety engineering rules. Nevertheless, improper use can result in danger to operator all third party life and limb, and product damage and additional property damage.



Duty to provide information on potential dangers

The product holder or user is obliged to make all operating personnel aware of dangers posed by this product.

Every person who is involved in the installation, operation or maintenance of the product must read, understand and adhere to the safety-related parts of this document.



Infringement of conformity due to modifications to the product

The Declaration of Conformity from the manufacturer is no longer valid if the operator changes the original product or installs additional equipment.

- Following the installation into a system, the operator is required to check and re-evaluate the conformity of the overall system in the context of the relevant European Directives, before commissioning that system.

Meet fundamental safety measures

1. When handling the gases and contaminated parts used, observe the applicable guidelines.
2. Observe the protective measures.
3. Observe the safety guidelines specified in this document.
 - All work is only permissible when observing the relevant guidelines and adhering to the protective measures.
4. Inform yourself about any contamination before starting work.
5. Pass on safety instructions to all other users.

2.4 Proper use

The total pressure measuring and control unit is used together with the Pfeiffer Vacuum CenterLine gauges to measure total pressures. Typical applications are measurement, monitoring and process control tasks in vacuum systems.



Using the product according to its intended purpose

1. Install, operate and maintain the product only in accordance with these operating instructions.
2. Comply with the application limits.
3. Observe the technical data.

2.5 Foreseeable improper use

Improper use of the product invalidates all warranty and liability claims. Any use that is counter to the purpose of the product, whether intentional or unintentional, is regarded as misuse, in particular:

- Use outside the mechanical and electrical application limits (technical data)
- Use with corrosive or explosive media, if this is not explicitly permitted
- Use outdoors
- Use after technical changes (on the inside or the outside of the product)
- Use with replacement or accessory parts that are unsuitable or are not approved

2.6 Responsibilities and warranty

Pfeiffer Vacuum shall assume no responsibilities and warranty if the operating company or a third party:

- disregards this document.
- does not use the product for its intended purpose.
- carries out any modifications to the product (conversions, changes, maintenance work, etc.) that are not listed in the corresponding operating instructions.
- operates the product with accessories that are not listed in the corresponding operating instructions.

The operator is responsible for the process media used.

2.7 Owner requirements**Safety-conscious working**

1. Only operate the product in a technically flawless state.
2. Operate the product in line with its intended purpose, safety and hazard-conscious and only in compliance with these operating instructions.
3. Fulfill the following instructions and monitor the observation of the following instructions:
 - Proper use
 - Generally applicable safety instructions and accident prevention regulations
 - International, national and locally applicable standards and guidelines
 - Additional product-related guidelines and regulations
4. Only use original parts or parts approved by Pfeiffer Vacuum.
5. Keep the operating instructions available at the place of installation.
6. Ensure personnel qualification.

2.8 Personnel qualification

The work described in this document may only be carried out by persons who have appropriate professional qualifications and the necessary experience or who have completed the necessary training as provided by Pfeiffer Vacuum.

Training people

1. Train the technical personnel on the product.
2. Only let personnel to be trained work with and on the product when under the supervision of trained personnel.
3. Only allow trained technical personnel to work with the product.
4. Before starting work, make sure that the commissioned personnel have read and understood these operating instructions and all applicable documents, in particular the safety, maintenance and repair information.

2.8.1 Ensuring personnel qualification

Specialist for mechanical work

Only a trained specialist may carry out mechanical work. Within the meaning of this document, specialists are people responsible for construction, mechanical installation, troubleshooting and maintenance of the product, and who have the following qualifications:

- Qualification in the mechanical field in accordance with nationally applicable regulations
- Knowledge of this documentation

Specialist for electrotechnical work

Only a trained electrician may carry out electrical engineering work. Within the meaning of this document, electricians are people responsible for electrical installation, commissioning, troubleshooting, and maintenance of the product, and who have the following qualifications:

- Qualification in the electrical engineering field in accordance with nationally applicable regulations
- Knowledge of this documentation

In addition, these individuals must be familiar with applicable safety regulations and laws, as well as the other standards, guidelines, and laws referred to in this documentation. The above individuals must have an explicitly granted operational authorization to commission, program, configure, mark, and earth devices, systems, and circuits in accordance with safety technology standards.

Trained individuals

Only adequately trained individuals may carry out all works in other transport, storage, operation and disposal fields. Such training must ensure that individuals are capable of carrying out the required activities and work steps safely and properly.

2.8.2 Personnel qualification for maintenance and repair



Advanced training courses

Pfeiffer Vacuum offers advanced training courses to maintenance levels 2 and 3.

Adequately trained individuals are:

- **Maintenance level 1**
 - Customer (trained specialist)
- **Maintenance level 2**
 - Customer with technical education
 - Pfeiffer Vacuum service technician
- **Maintenance level 3**
 - Customer with Pfeiffer Vacuum service training
 - Pfeiffer Vacuum service technician

2.8.3 Advanced training with Pfeiffer Vacuum

For optimal and trouble-free use of this product, Pfeiffer Vacuum offers a comprehensive range of courses and technical trainings.

For more information, please contact [Pfeiffer Vacuum technical training](#).

2.9 Operator requirements

Observing relevant documents and data

1. Read, observe and follow this operating instruction and the work instructions prepared by the operating company, in particular the safety and warning instructions.
2. Install, operate and maintain the product only in accordance with these operating instructions.
3. Carry out all work only on the basis of the complete operating instructions and applicable documents.
4. Comply with the application limits.
5. Observe the technical data.
6. Please contact the Pfeiffer Vacuum Service Center if your questions on operation or maintenance of the product are not answered by these operating instructions.
 - You can find information in the [Pfeiffer Vacuum service area](#).



3 Transportation and storage

NOTICE

Damage caused by incorrect transportation

Transportation in unsuitable packaging, or failure to install all transport locks, can damage the product.

- ▶ Comply with the instructions for safe transportation.

NOTICE

Damage caused by improper storage

Improper storage will lead to damage to the product.

Static charging, moisture, etc. lead to defects on the electronic components.

- ▶ Comply with the instructions for safe storage.

Transporting the product safely

1. Observe the weight of the product.
2. Where possible, always transport or ship the product in the original packaging.
3. Always use dense and impact-proof packaging for the product.
4. Remove the existing protective cover and transport protections only immediately prior to installation.
5. Reattach transport locks and transport protections prior to each transport.

Storing the product safely

1. Store the product in a cool, dry, dust-free place, where it is protected against impacts and mechanical vibration.
2. Always use dense and impact-proof packaging for the product.
3. Where possible, store the product in the original packaging.
4. Store electronic components in antistatic packaging.
5. Maintain the permissible storage temperature.
6. Avoid extreme fluctuations of the ambient temperature.
7. Avoid high air humidity.
8. Seal connections with the original protective caps.
9. Protect the product with the original transport protections (where available).



4 Product description

4.1 Identifying the product

You will need all the data from the rating plate to safely identify the product when communicating with Pfeiffer Vacuum.

Recording rating plate data

1. Read the data on the product rating plate.
2. Record this data.
3. Always have all rating plate specifications to hand.

4.2 Scope of delivery

The shipment includes the following parts:

- 1 × total pressure measuring and control unit
- 1 × network cable (country-specific)
- 2 × cable connectors (control/relay)
- 4 × collar screws with synthetic nipple
- 2 × rubber feet
- 1 × rubber strip
- 1 × installation instructions
- 1 × operating instructions

Unpacking the product and checking completeness of the shipment

1. Unpack the product.
2. Remove the transport fasteners, transport protection etc.
3. Store the transport fasteners, transport protection etc. in a safe place.
4. Check that the shipment is complete.
5. Ensure that no parts are damaged.

4.3 Design, construction

DANGER

Danger to life from electric shock

The internal earthed conductor is fastened to the housing by a screw. A device without an earthed conductor attached can be life-threatening in the event of a malfunction.

- ▶ Do not rotate or loosen the screw on the internal earthed conductor.



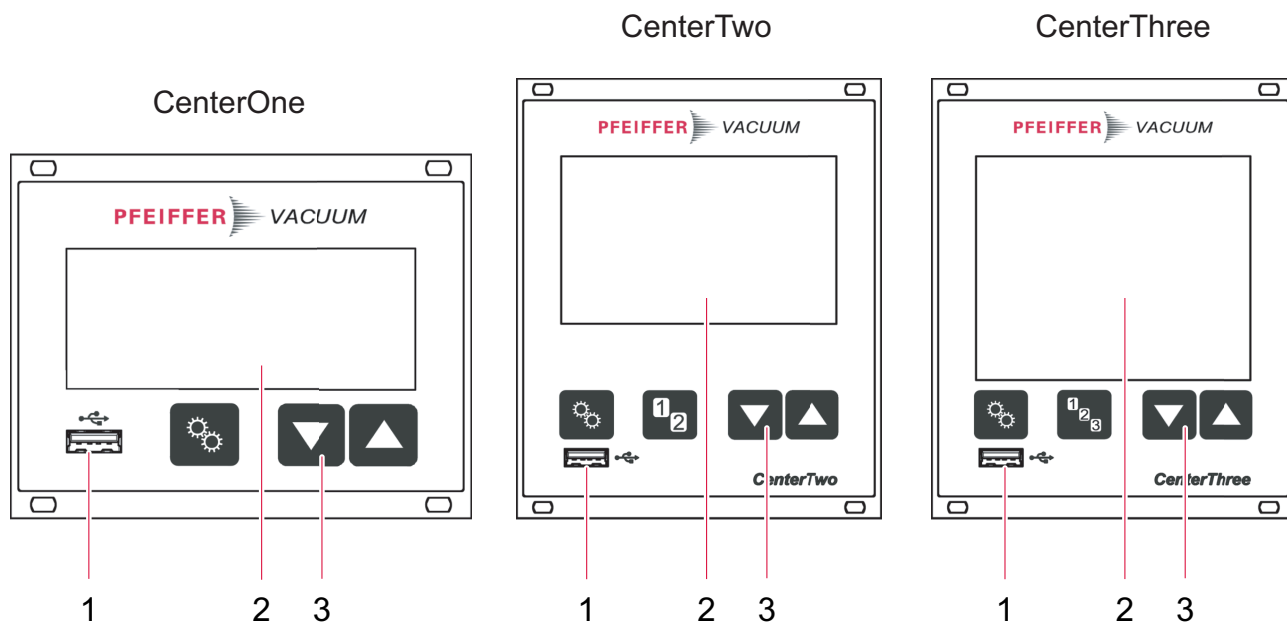

Fig. 2: Front panel

- 1 USB connection (type A)
- 2 Display
- 3 Controls

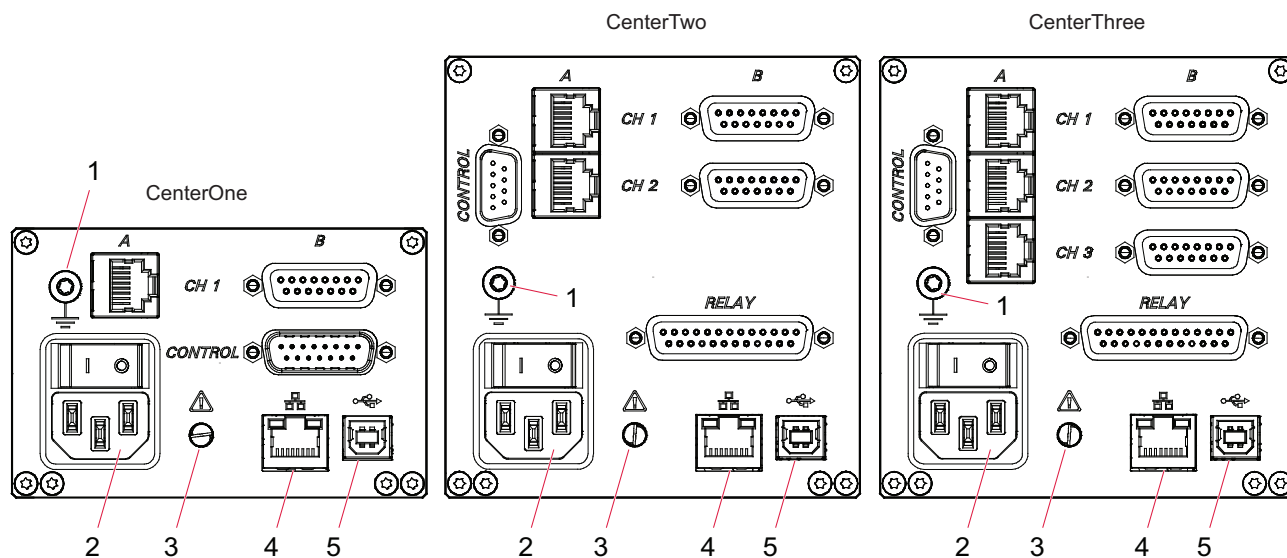

Fig. 3: Connections on the rear side

- 1 Ground terminal
- 2 Mains power supply
- 3 Internal earthed conductor
- 4 Ethernet interface
- 5 USB connection (type B)
- CONTROL "CONTROL" connection for control functions
- RELAY "RELAY" connection with relay contacts
- CH 1-3 (A) Connections "CH 1" to "CH 3" for gauges (RJ-45 socket)
- CH 1-3 (B) Connections "CH 1" to "CH 3" for gauges (D-Sub socket)

4.4 Display elements

Display elements of the device

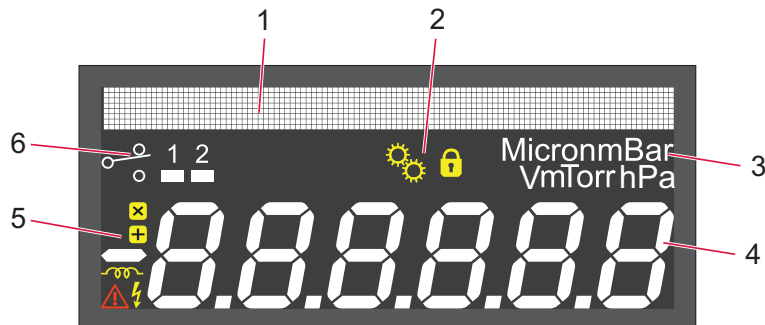

Fig. 4: Display CenterOne

- | | | | |
|---|------------------------------|---|----------------------------|
| 1 | Parameter or bar graph | 4 | Measurement channel value |
| 2 | Parameter mode or input lock | 5 | Measurement channel status |
| 3 | Unit of pressure or voltage | 6 | Switch-points |

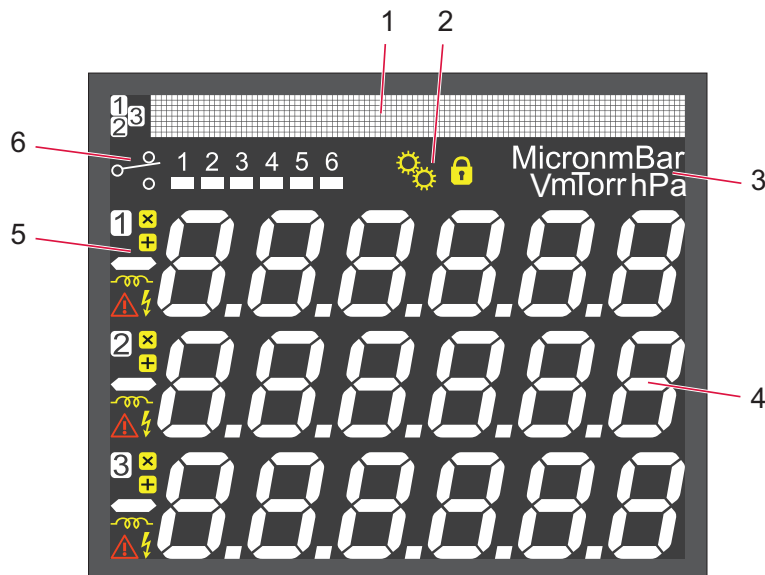

Fig. 5: Display CenterTwo and CenterThree

- | | | | |
|---|------------------------------|---|----------------------------|
| 1 | Parameter or bar graph | 4 | Measurement channel value |
| 2 | Parameter mode or input lock | 5 | Measurement channel status |
| 3 | Unit of pressure or voltage | 6 | Switch-points |



Fig. 6: Exponential illustration of the measurement channel measured value (examples)



Parameter or bar graph

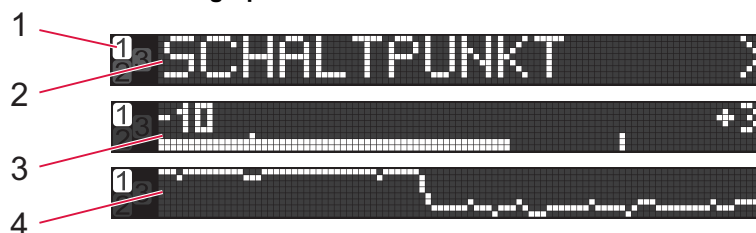

Fig. 7: Parameter or bar graph

- | | | | |
|---|-----------------------------------|---|---|
| 1 | Display for measurement channel 1 | 3 | Bar graph with switch-point for measurement channel 1 |
| 2 | Parameter display | 4 | Pressure vs. time, trend for measurement channel 1 |

Switch-points, parameter mode and input lock



Fig. 8: Switch-points, parameter mode and input lock

- | | | | |
|---|---------------------------------|---|-------------|
| 1 | Switch-points from relay 1 to 6 | 4 | Relay 3 off |
| 2 | Parameter mode activated | 5 | Relay 1 on |
| 3 | Input lock activated | | |

Measurement channel status

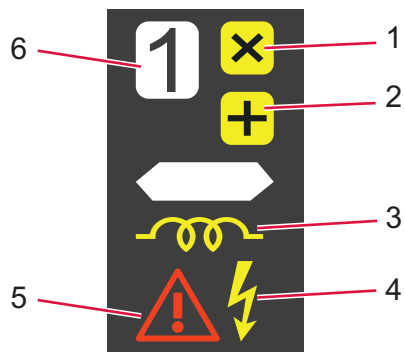





Fig. 9: Measurement channel status

- | | | | |
|---|-----------------------------------|---|-------------------------------|
| 1 | Calibration factor (COR) | 4 | High-vacuum measuring circuit |
| 2 | Offset | 5 | Error |
| 3 | Degas or CTR 100 in warm-up phase | 6 | Measurement channel |



4.5 Controls

Key	Designation	Functions (depending on operating mode)
	Parameter	<ul style="list-style-type: none"> • Change to parameter mode • Select parameter/group • Confirm selection • Save changes and return to read mode
	Measurement channel	Change measurement channel (only for CenterTwo and CenterThree)
	UP and DOWN arrow keys	<ul style="list-style-type: none"> • Select parameter • Press for < 1 second: Increase/reduce/change value by increments • Press for > 1 second: Increase/reduce/change value continually

Tbl. 5: Controls

4.6 Interfaces

4.6.1 Mains power supply

⚠ DANGER

Danger to life from electric shock

Inadequate or incorrect grounding of the unit leads to contact-sensitive voltage on the housing. When making contact, increased leakage currents will cause a life-threatening electric shock.

- ▶ Before the installation, check that the connection leads are voltage-free.
- ▶ Conduct the electrical connection in accordance with locally applicable regulations.
- ▶ Make sure that the local mains voltage and frequency match rating plate specifications.
- ▶ Make sure that the mains cable and extension cable meet the requirements for double isolation between input voltage and output voltage, in accordance with IEC 61010 and IEC 60950.
- ▶ Use only a 3-pin mains cable and extension cable with properly connected protective earthing (earthed conductor).
- ▶ Plug the mains plug into a socket with earthing contact only.
- ▶ Always connect the mains cable prior to all other cables, to ensure continuous protective earthing.

The mains connection with mains switch is located on the rear side of the device. A mains cable is included in the shipment. If the mains plug is not compatible with your system, you can use a separate, suitable mains cable with earthed conductor ($3 \times 1.5 \text{ mm}^2$). If you install the device in a control cabinet, we recommend that you supply the mains voltage via a switched mains distributor. **The socket requires a 10 A fuse_{max}.**

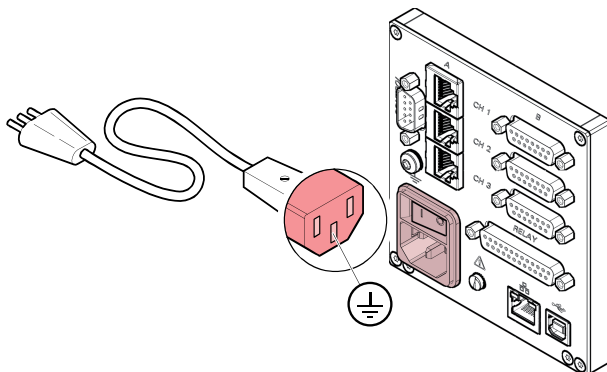

Fig. 10: Mains connection with IEC 320 C13 socket



4.6.2 Ground terminal

⚠ DANGER

Danger to life from electric shock

The internal earthed conductor is fastened to the housing by a screw. A device without an earthed conductor attached can be life-threatening in the event of a malfunction.

- ▶ Do not rotate or loosen the screw on the internal earthed conductor.

The connection to the protective earthing is located on the rear side of the device. Using the screw, you can connect the device where required via an earthed conductor to the protective earthing of the pumping station, for example.

4.6.3 "CH" connection (channel)

⚠ DANGER

Danger to life due to dangerous contact voltage

Voltages above 30 V (AC) or 60 V (DC) are considered dangerous in accordance with IEC 61010. If you come into contact with dangerous contact voltage, this can result in injury through electric shocks or even death.

- ▶ Only apply protected extra-low voltage (PELV).

NOTICE

Damage caused by connection from CH A and CH B

Connecting CH A and CH B of a measurement channel at the same time damages the connected gauges.

- ▶ Always only connect CH A or CH B.

Two parallel circuit connections are available for each measurement channel for connecting a gauge. You can connect the gauges using an preconfigured measurement cable or a self-assembled, screened cable (EMC compatibility) at the "CH" connection on the rear side of the device. Please note the list of usable gauges.

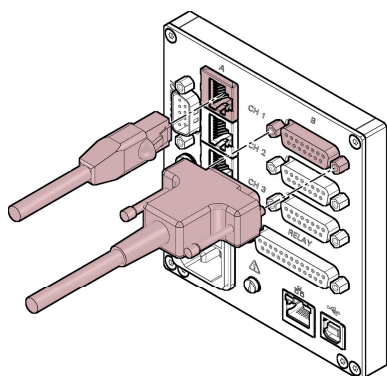

Fig. 11: Connections A and B on the measuring channels

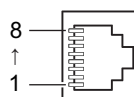

Fig. 12: Connection CH A (RJ-45 socket)

- | | |
|--|-----------------|
| 1 Supply (24 V DC) | 5 Signal earth |
| 2 Supply earth (GND) | 6 Status |
| 3 Signal input (measuring signal 0 – +10 V DC) | 7 HV_L |
| 4 Identification | 8 HV_H / HV_EMI |

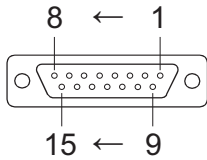

Fig. 13: Connection CH B (D-Sub socket)

- | | |
|--|------------------------|
| 1 EMI status | 9 n.c. |
| 2 Signal input (measuring signal 0 – +10 V DC) | 10 Identification |
| 3 Status | 11 Supply (24 V DC) |
| 4 HV_H / HV_EMI | 12 Signal earth |
| 5 Supply earth (GND) | 13 Receive data (RxD) |
| 6 n.c. | 14 Transmit data (TxD) |
| 7 Degas | 15 Housing (GND) |
| 8 Supply (24 V DC) | |

4.6.4 "CONTROL" connection (CenterOne)

⚠ DANGER

Danger to life due to dangerous contact voltage

Voltages above 30 V (AC) or 60 V (DC) are considered dangerous in accordance with IEC 61010. If you come into contact with dangerous contact voltage, this can result in injury through electric shocks or even death.

► Only apply protected extra-low voltage (PELV).

Via this connection, you can read the measurement signal, perform a zero potential evaluation of the state of the switching function and malfunction monitoring system, and switch the high vacuum measuring circuit on/off (for PTR cold cathode gauges). A suitable cable plug is included in the device shipment. You can connect the peripheral components with a self-assembled, screened cable (EMC compatibility) to the connection on the rear side of the device.

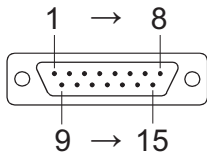

Fig. 14: "CONTROL" connection (15-pole D-Sub plug)

- | | |
|--|---------------------------------|
| 1 Analog output (-5 to +13 V DC) ¹⁾ | 8 Housing (GND) |
| 2 Analog output (GND) | 9, 10, 11 Error signal (error) |
| 3, 4, 5 Switching function 1 | 12, 13, 14 Switching function 2 |
| 6 HV_H (on: +24 V; off: 0 V) | 15 Housing (GND) |
| 7 +24 V (DC), 200 mA ²⁾ | |

Pins	Switching function	Description	Switching function	Description
3	12			Pressure higher than threshold value or device switched off
4	13			
5	14			
				Pressure lower than threshold value

1) The deviation between the analog output (pole 1) and the display on the device equates to max. ±20 mV.
 2) Supply for relays with higher switching power. Fused at 300 mA with PTC element, self-resetting after switching off the device or unplugging the "control" plug. Meets the requirements of protected extra-low voltage (PELV).



Pins	Switching function	Description	Switching function	Description
9		No errors		Error or device switched off
10				
11				

Tbl. 6: Switching functions

4.6.5 "CONTROL" connection (CenterTwo/CenterThree)

⚠ DANGER

Danger to life due to dangerous contact voltage

Voltages above 30 V (AC) or 60 V (DC) are considered dangerous in accordance with IEC 61010. If you come into contact with dangerous contact voltage, this can result in injury through electric shocks or even death.

- ▶ Only apply protected extra-low voltage (PELV).

You can use this connection to read the measurement signal and switch the high-vacuum measuring circuit on/off (for PTR cold cathode gauges). The logger output is a programmable analog output that you can assign to any measurement channel. A suitable cable plug is included in the device shipment. You can connect the peripheral components with a self-assembled, screened cable (EMC compatibility) to the connection on the rear side of the device.

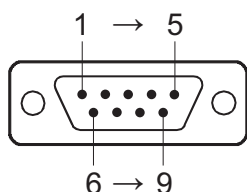

Fig. 15: "CONTROL" connection (9-pole D-Sub plug)

- | | |
|--|--|
| 1 Analog output 1 (-5 to +13 V DC) ³⁾ | 6 Analog output 2 (-5 to +13 V DC) ⁴⁾ |
| 2 Analog output 3 (-5 to +13 V DC) ⁵⁾ | 7 Logger output (0 to +10 V DC) |
| 3 Screening (GND) | 8 Screening (GND) |
| 4 HV_EMI 3 | 9 HV_EMI 2 |
| 5 HV_EMI 1 | |

4.6.6 "RELAY" connection (only CenterTwo/CenterThree)

⚠ DANGER

Danger to life due to dangerous contact voltage

Voltages above 30 V (AC) or 60 V (DC) are considered dangerous in accordance with IEC 61010. If you come into contact with dangerous contact voltage, this can result in injury through electric shocks or even death.

- ▶ Only apply protected extra-low voltage (PELV).

You can use this connection to perform a zero-potential (floating) evaluation of the malfunction monitoring system status and use the zero potential status of the switching functions for external control. A suitable cable plug is included in the device shipment. You can connect the peripheral components with a self-assembled, screened cable (EMC compatibility) to the connection on the rear side of the device.

- 3) The deviation between the analog output (pole 1, 2, 6) and the display on the device equates to max. ± 20 mV.
- 4) The deviation between the analog output (pole 1, 2, 6) and the display on the device equates to max. ± 20 mV.
- 5) The deviation between the analog output (pole 1, 2, 6) and the display on the device equates to max. ± 20 mV.



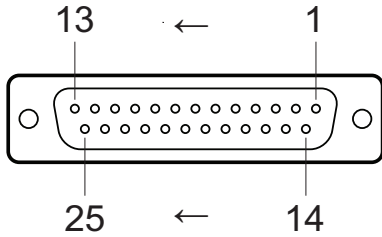

Fig. 16: "RELAY" connection (25-pole D-Sub socket)

1, 7	Earth (GND) ⁶⁾	16, 17, 18	Switching function 4
25	+24 V (DC), 200 mA ⁷⁾	19, 20, 21	Switching function 5
4, 5, 6	Switching function 1	22, 23, 24	Switching function 6
8, 9, 10	Switching function 2	3, 14, 15	Error signal (error)
11, 12, 13	Switching function 3	2	unassigned

Pins	Switching function	Description	Switching function	Description
4 8 11 16 19 22		Pressure higher than threshold value or device switched off		Pressure lower than threshold value
5 9 12 17 20 23				
6 10 13 18 21 24				
3 15 14		Error or device switched off		No errors

Tbl. 7: Switching functions

4.6.7 "USB" connection (type B)

The "USB" connection (type B) enables direct communication with the device via a computer (e.g. firmware updates, storing parameters (reading/writing)). You can connect the USB interface with a screened cable (EMC compatibility) to the connection on the rear side of the device.

If a virtual series interface (COM) is not automatically set up, you can download the driver from [FTDI Chip \(Virtual COM Port Drivers\)](#) and then install it.

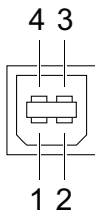

Fig. 17: "USB" connection (type B)

1	VBUS (5 V)	3	D+
2	D-	4	Ground (GND)

4.6.8 "USB" connection (type A)

The "USB" connection (type A) with master functionality is located on the front side and is used to connect a USB memory stick (e.g. firmware updates, storing parameters (reading/writing), data logger).

- 6) Supply for relays with higher switching power. Fused at 200 mA with PTC element, self-resetting after switching off the device or after unplugging the "relay" plug. Meets the requirements of protected extra-low voltage (PELV).
- 7) Supply for relays with higher switching power. Fused at 200 mA with PTC element, self-resetting after switching off the device or after unplugging the "relay" plug. Meets the requirements of protected extra-low voltage (PELV).



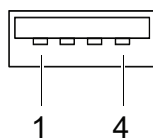

Fig. 18: "USB" connection (type A)

- | | | | |
|---|------------|---|-------------|
| 1 | VBUS (5 V) | 3 | D+ |
| 2 | D- | 4 | Earth (GND) |

4.6.9 "Ethernet" (LAN) connection

The "Ethernet" connection enables direct communication with the device via a computer.

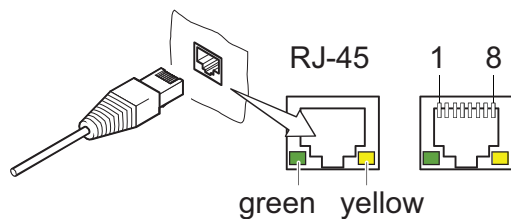

Fig. 19: "Ethernet" (LAN) connection

- | | | | |
|---|-------------------------|------------|----------------------|
| 1 | Transmission data (TD+) | 6 | Reception data (RD-) |
| 2 | Transmission data (TD-) | 4, 5, 7, 8 | Not used |
| 3 | Reception data (RD+) | | |

LED	Status	Meaning
Green (link)	lights up	Hardware connection exists
	dark	No hardware connection
Yellow (activity)	lit up (flickering)	Data transmission runs
	dark	no data transmission / no connection

Tbl. 8: Status of the Ethernet connection

5 Installation

5.1 Installing the device in a 19" rack

NOTICE

Damage caused by overheating

The ambient temperature must not exceed the permissible operating temperature of the device.

- ▶ Make sure there is unobstructed circulation of air when installing the device.
- ▶ Make sure that air can enter and exit through the ventilation openings without obstruction.
- ▶ Do not cover the ventilation openings.
- ▶ Periodically check and clean the installed air filter.

NOTICE

Loss of control cabinet protection class

As a built-in unit, the device can negate the required protection class (protection against foreign matter and water) of control cabinets according to IEC 60204-1, for example.

- ▶ Take suitable measures to reestablish the required protection class.

You can insert the device in a 19" rack module adapter as per DIN 41 494. For this purpose, 4 collar screws and synthetic nipples are included in the shipment. For a 3 height unit installation, an adapter plate including 2 collar screws and synthetic nipples is available as an accessory for the CenterOne.

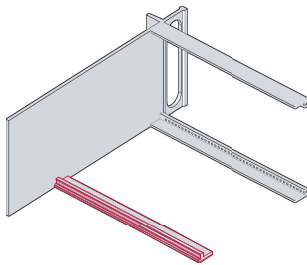

Fig. 20: Guide rails

Installing guide rails

- ▶ Install guide rails on the rack module adapter.
 - This is used for load relieving on the front panel of the device.

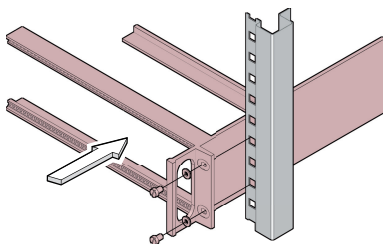

Fig. 21: Rack module adapter (2 height units, only CenterOne)

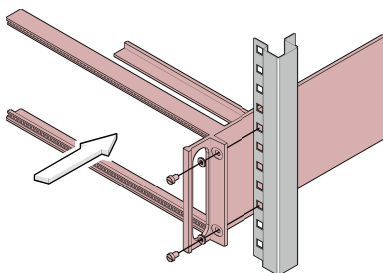

Fig. 22: Rack module adapter (3 height units)



Fastening the rack module adapter

- ▶ Fasten the rack module adapter in the rack cabinet.

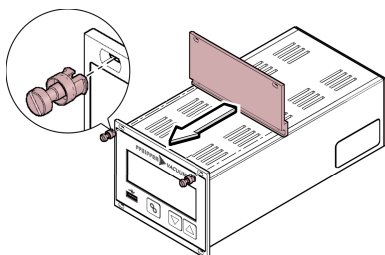

Fig. 23: Adapter plate (only CenterOne with 3 height unit rack module adapter)

Attaching the adapter plate

Required tools

- Screwdriver

Required material

- 2 × collar screws and synthetic nipple
- ▶ Attach the adapter plate to the device using 2 collar screws and synthetic nipples.

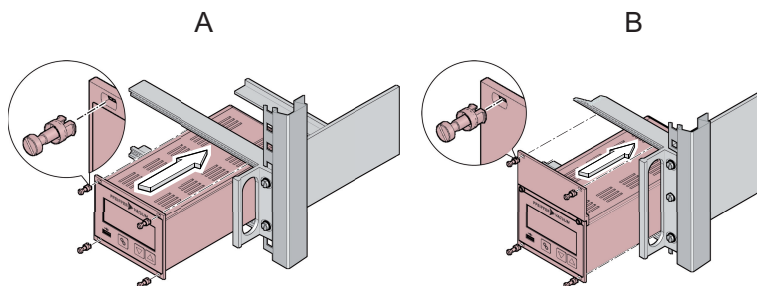

Fig. 24: Installing the CenterOne

A Rack module adapter (2 height units)

B Rack module adapter (3 height units), with adapter plate

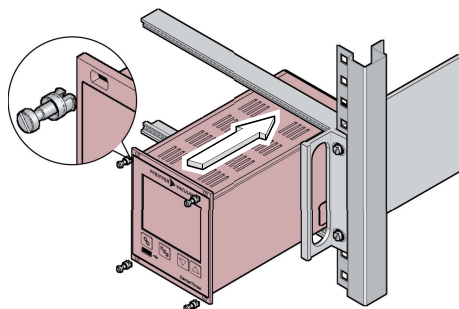

Fig. 25: Install CenterTwo/CenterThree

Installing the device in the rack module adapter

Required tools

- Screwdriver

Required material

- 4 × collar screws and synthetic nipple
- Slide rails (optional)

1. Recommendation: Install the slide rails in the rack frame for safe and easy installation of heavy rack module adapters.
2. Push the device into the rack module adapter.
3. Fasten the device using the screws included in the shipment.



5.2 Installing the device in a switchboard

NOTICE

Damage caused by overheating

The ambient temperature must not exceed the permissible operating temperature of the device.

- ▶ Make sure there is unobstructed circulation of air when installing the device.
- ▶ Make sure that air can enter and exit through the ventilation openings without obstruction.
- ▶ Do not cover the ventilation openings.
- ▶ Periodically check and clean the installed air filter.

NOTICE

Loss of control cabinet protection class

As a built-in unit, the device can negate the required protection class (protection against foreign matter and water) of control cabinets according to IEC 60204-1, for example.

- ▶ Take suitable measures to reestablish the required protection class.

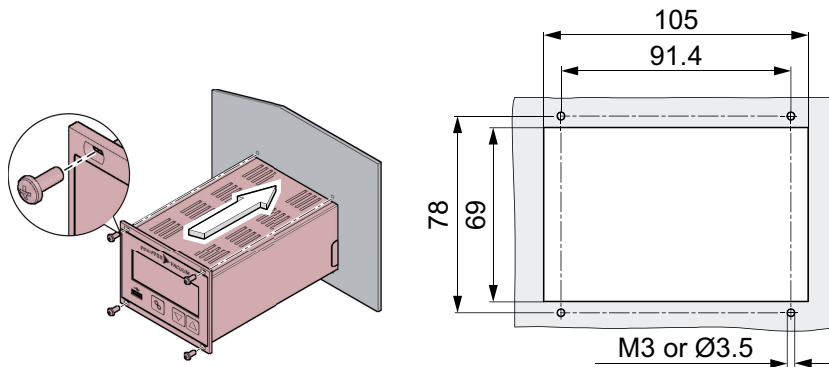

Fig. 26: Required control panel cut-out (CenterOne)

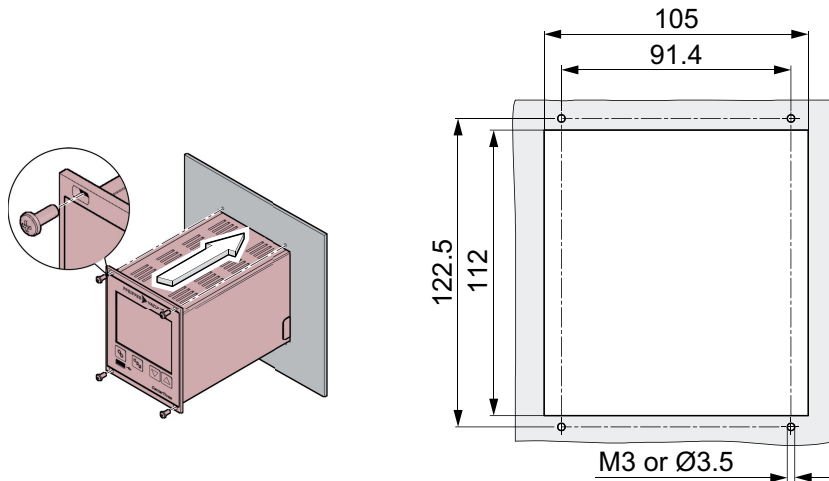

Fig. 27: Required control panel cut-out (CenterTwo/CenterThree)

Installing the device in a switchboard

Required tools

- Screwdriver

Required material

- 4 screws (M3 or equivalent)
1. Support the device from below to relieve the front panel.
 2. Push the device into the control panel cut-out.



3. Support the device to relieve the front panel.
4. Fasten the device using 4 screws.

5.3 Using the device as a desktop device

NOTICE

Damage caused by overheating

The ambient temperature must not exceed the permissible operating temperature of the device.

- ▶ Make sure there is unobstructed circulation of air when installing the device.
- ▶ Make sure that air can enter and exit through the ventilation openings without obstruction.
- ▶ Do not cover the ventilation openings.
- ▶ Periodically check and clean the installed air filter.

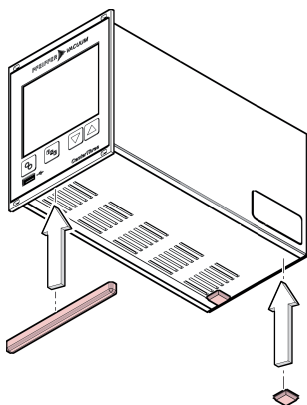

Fig. 28: Fastening the rubber feet and rubber strip

Using the device as a desktop device

You can use the device as a desktop device. The shipment includes two self-adhesive rubber feet as well as an attachable rubber strip, for this purpose.

Required material

- 2 self-adhesive rubber feet
 - 1 attachable rubber strip
1. Stick the 2 rubber feet at the rear side on the housing base.
 2. Stick the rubber strip on the front panel from underneath.



6 Commissioning

6.1 Switch on the device

Prerequisites

- You have installed the device correctly.
- You have adhered to the technical data.
- ▶ Switch on the device at the mains switch.
- ▶ **For rack assembly:** Switch on the device centrally via the switched mains distributor.

After switching on:

- The device performs a self test.
- The device identifies the connected gauges.
- The device activates the parameters that were in place on last switching off.
- The device switches to measuring mode.
- The device adjusts the parameters if necessary, if another gauge was connected previously.

6.2 Updating the firmware

If your device requires a more recent firmware version, in order to support new gauges for example, please contact your nearest Pfeiffer Vacuum Service Center.

A firmware update can be performed

- using a USB memory stick (USB type A on the front side of the device) or
- using the USB Update Tool via the USB type B connection on the rear side of the device.



USB memory sticks

The device does not recognize all USB memory sticks, for instance if they do not comply with the USB standard. Try using a different memory stick first before you contact your nearest Pfeiffer Vacuum Service Center.

The settings you changed in parameter mode are usually also available after performing a firmware update. However, we recommend that you store the parameters before performing an update (set-up mode).

Updating via a USB memory stick is an automatic process with the following steps:

1. **BOOTING**
 - very short
2. **BOOTLOADER V1.x**
 - very short
3. **ERASING FW...**
 - Old firmware is deleted from the device.
4. **UPDATING FW...**
 - New firmware is written to the device.
5. **UPDATE COMPLETE**
 - Update is done.

Updating the firmware with a USB memory stick (USB type A)

1. Open the Pfeiffer Vacuum [Download Center](#) in the browser.
2. Enter the name of your device as the keyword.
3. Select "Software".
 - The display lists the available documents and software.
4. Download the ZIP file in the desired language.
 - The ZIP file contains the files with file extension ".S19" and ".CNF".
5. Unzip both files.
6. Save both files on the USB memory stick.
7. Turn off the device.
8. Plug the USB memory stick into the device.
9. Turn on the device.
 - The update takes place automatically.



10. Remove the USB memory stick from the device.
 - The device automatically restarts.
11. If required, write the customer-specific settings that were stored before the update back to the device.

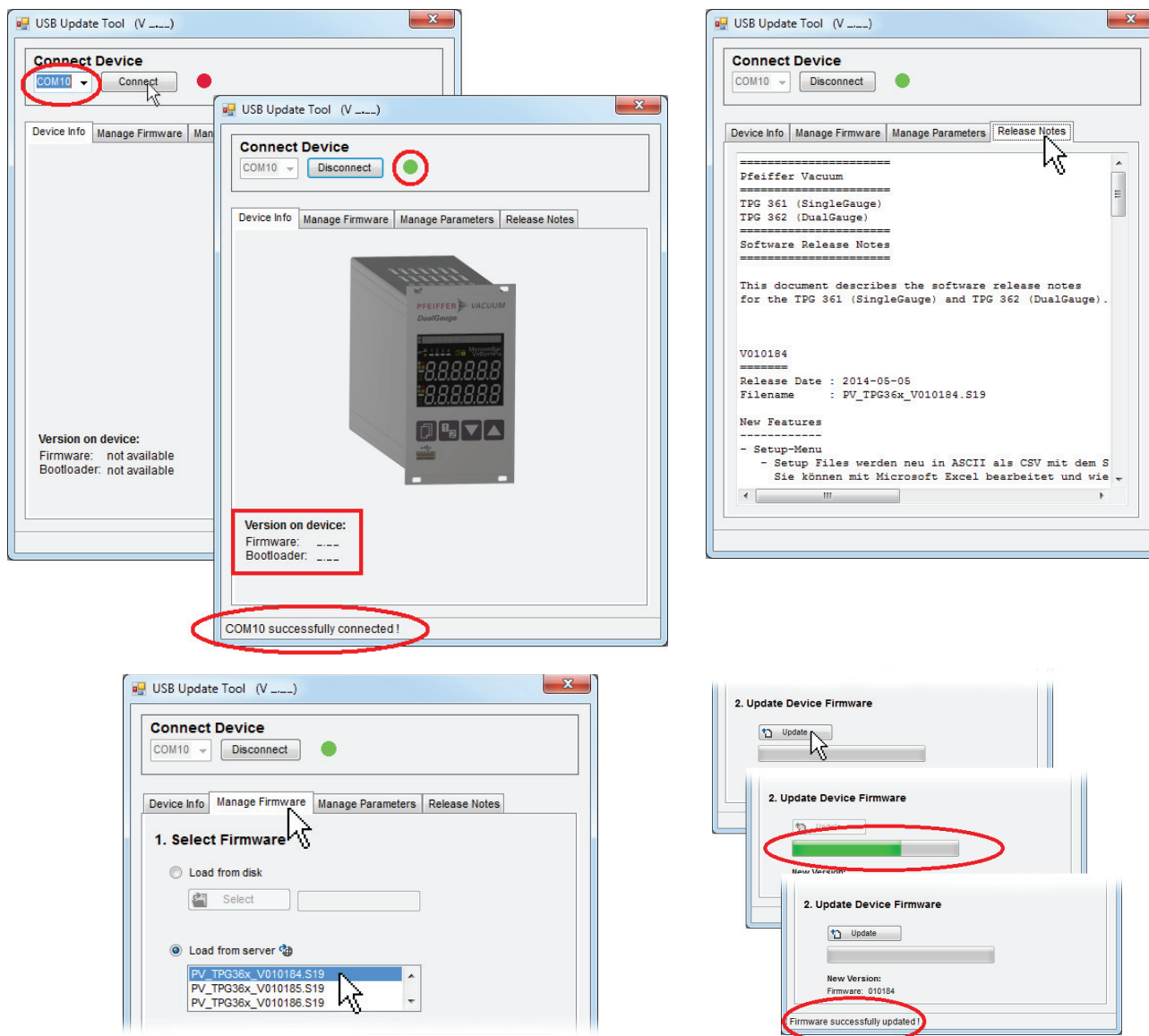

Fig. 29: USB Update Tool

Updating the firmware with the USB Update Tool (USB type B)

If a virtual series interface (COM) is not automatically set up, you can download the driver from [FTDI Chip \(Virtual COM Port Drivers\)](#) and then install it.

Prerequisites

- You must use the Windows XP, 7, 8 or 10 operating system.
- Make sure there is no USB memory stick connected to the front side of the device.

1. Open the Pfeiffer Vacuum [Download Center](#) in the browser.
2. Enter "USB Update Tool" as the keyword.
 - The display lists the available software.
3. Download the file in the desired language.
4. Connect the device to the PC using a USB cable (type A/B).
5. Start the USB Update Tool.
6. Select the COM interface from the selection list.
7. Click on "Connect".

8. Go to the "Release Notes" tab.
 - You will find the change log here.
9. Go to the "Manage Parameters" tab.
 - We recommend that you store the parameters here before performing an update.
10. Go to the "Manage Firmware" tab.
11. Select the firmware.
 - <Load from disk> (local file) or <Load from server> (server connection).
12. Click on "Update".
 - After the update, the status message "Firmware successfully updated!" appears at the bottom edge of the window.
13. If the update was not successful, repeat the procedure.
14. Go to the "Manage Parameters" tab.
15. Write the parameters back to the device.

6.3 Configuring Ethernet

Connecting the device to a network with registration

1. Read the MAC address of the device.
2. Allow the network administrator to register the device on the network.
3. Ask for the Ethernet parameters (IP ADDRESS, GATEWAY, NETMASK, and DHCP).
4. Configure the device.
5. Use the Ethernet Configuration Tool to search for the device on the network.
6. Assign a virtual COM interface.
7. Start the program to communicate with the device.
8. Connect the device to the assigned COM interface.

Connecting the device to a network without registration

1. Ask your network administrator for the Ethernet parameters (IP ADDRESS, GATEWAY, NETMASK, and DHCP) if you do not know them.
2. Configure the device.
3. Use the Ethernet Configuration Tool to search for the device on the network.
4. Assign a virtual COM interface.
5. Start the program to communicate with the device.
6. Connect the device to the assigned COM interface.

Configuring the device (connection to a network)

1. Save the parameters on a USB memory stick.
2. Set the following Ethernet parameters in the stored parameter file (file extension: CSV): IP ADDRESS, GATEWAY, NETMASK, and DHCP.
3. Write the changed parameters back to the device.
4. Connect the device to the network using an Ethernet patch cable.

Connecting the device to a computer with a DHCP server

1. Connect the device to the computer.
 - You can do this using an Ethernet crossover cable, a switch or an Ethernet patch cable (pre-requisite: the interface must be Auto MDI-X capable). The DHCP server automatically assigns an address. Requirements: DHCP = ON (factory setting)
2. Use the Ethernet Configuration Tool to search for the device on the network.
3. Assign a virtual COM interface.
4. Start the program to communicate with the device.
5. Connect the device to the assigned COM interface.

Connecting the device to a computer without DHCP server

1. Save the parameters on a USB memory stick.
2. Set the following Ethernet parameters in the stored parameter file (file extension: CSV):
 - IP ADDRESS: 192.168.0.1 (192.168.0.2 for a second device, etc.)
 - NETMASK: 255.255.0.0
 - DHCP: OFF
3. Write the changed parameters back to the device.
4. Connect the device to the computer.
 - You can do this using an Ethernet crossover cable, a switch or an Ethernet patch cable (pre-requisite: the interface must be Auto MDI-X capable). The DHCP server automatically assigns an address. Requirements: DHCP = ON (factory setting)



5. Use the Ethernet Configuration Tool to search for the device on the network.
6. Assign a virtual COM interface.
7. Start the program to communicate with the device.
8. Connect the device to the assigned COM interface.

Ethernet Configuration Tool

The Ethernet Configuration Tool enables the configuration of the Ethernet interface using a PC. Additionally, you can assign a virtual series interface (COM) to an IP address. You can access the virtual COM interfaces using every program that supports series interfaces (e.g. terminal program, LabView, etc.).

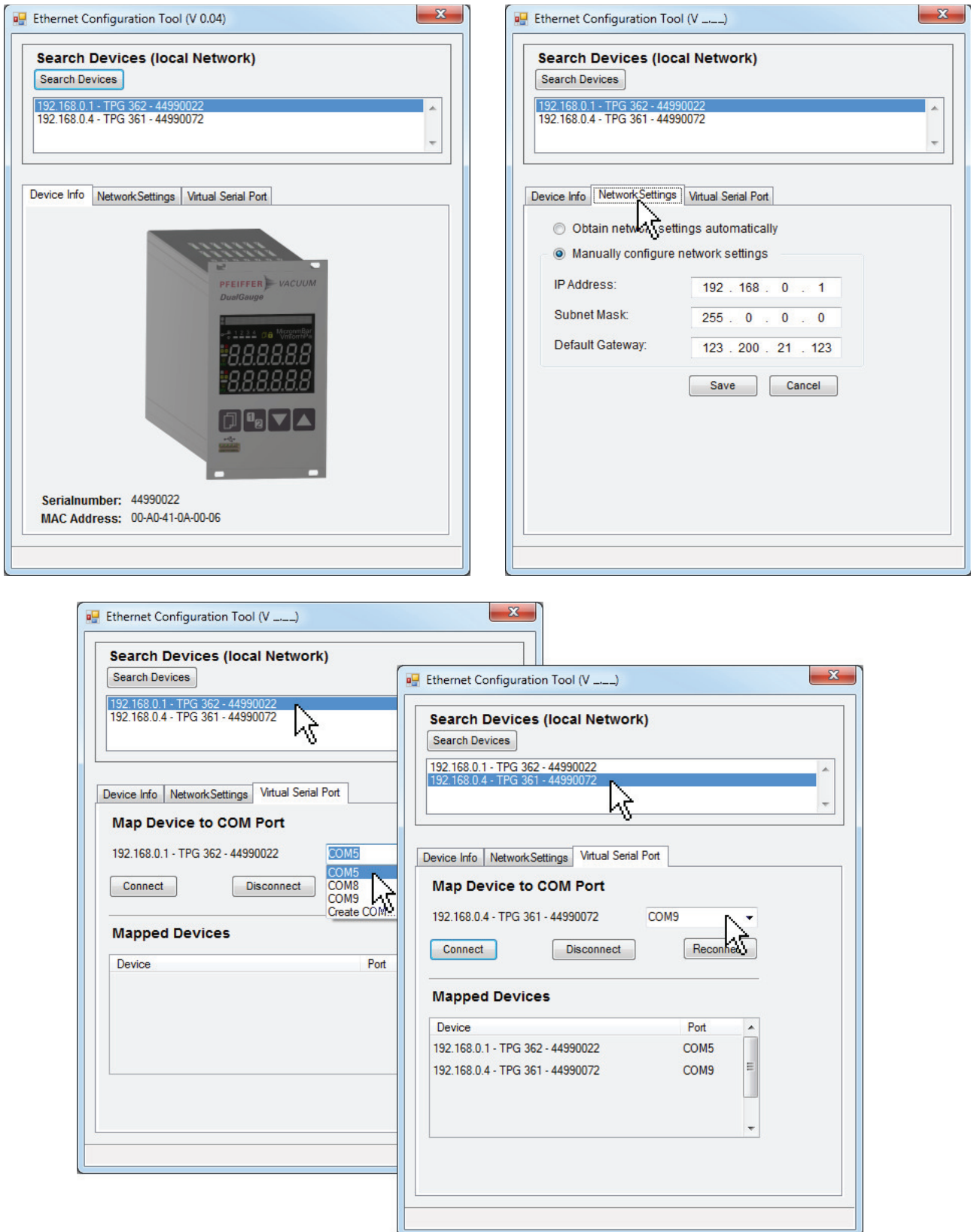

Fig. 30: Ethernet Configuration Tool

Ethernet Configuration Tool

- The "Device Info" tab displays basic information about the selected device.
- The automatic or manual network setting is made in the "Network Settings" tab.
- In the "Virtual Serial Port" tab, you can assign a separate COM port to each device and/or generate a new COM port.



Using the Ethernet Configuration Tool

Prerequisite

- You must use the Windows 7, 8 or 10 operating system.
- 1. Recommendation: Contact your network administrator before you start the configuration.
- 2. Recommendation: Update the operating system before you start the Ethernet configuration. You also require administrator rights.
- 3. Open the Pfeiffer Vacuum [Download Center](#) in the browser.
- 4. Enter "Ethernet Configuration Tool" as the keyword.
 - The display lists the available software.
- 5. Download the file in the desired language.
- 6. Connect the device to the network using an Ethernet cable.
- 7. Start the Ethernet Configuration Tool.
- 8. Click on "Search Devices".
 - The tool searches for connected devices on the local network and lists the devices it finds in the selection window.
- 9. Make the required settings in the program.



7 Operation

7.1 Basic operation

The following section provides information about the most important basic operations for the individual modes.

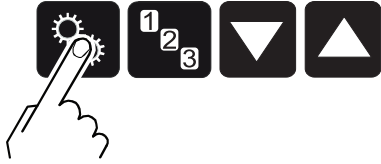
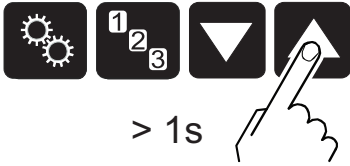
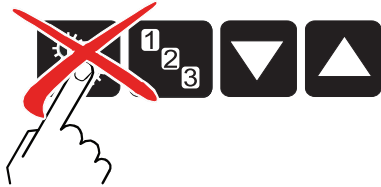
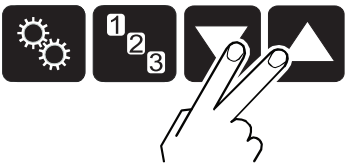
Operation	Description
	Press button
	Press button for longer than one second
	Do not press button
	Press buttons simultaneously

Tbl. 9: Description of the controls

7.2 Operating modes

The device operates in the following modes:

- **Measuring mode**
 - Display of measured value or status
- **Parameter mode**
 - Display and input of parameters:
 - Switching function parameter (**SWITCH-POINT**)
 - Gauge parameter (**SENSOR**)
 - Gauge control (**SENSOR CONTROL**)
 - General parameters (**GENERAL**)
 - Test program (**TEST**)
- **Data logger mode**
 - Recording of measured data (**DATA LOGGER**)
- **Setup mode**
 - Saving (reading/writing) parameters (**SETUP**)

7.3 Measuring mode

Measuring mode is the standard operations mode for the device:

- Displaying a bar graph (where required)
- Displaying a measured value per measurement channel
- Displaying status messages per measurement channel



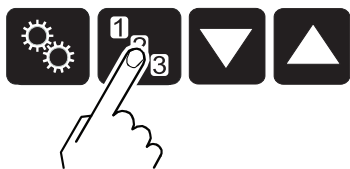

Fig. 31: Changing the measurement channel (only CenterTwo and CenterThree)

Change measurement channel

You can use the "Measurement channel" button to switch between measurement channels. The number of the selected measurement channel lights up.

- ▶ Press the "Measurement channel" button until the number of the desired measurement channel is displayed.

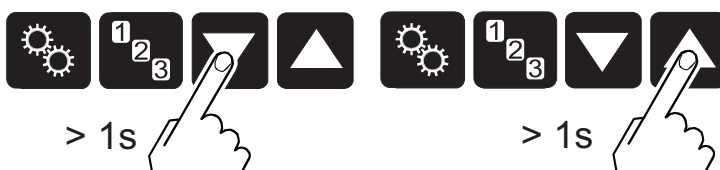

Fig. 32: Switching gauges on and off

Switching gauges on and off

You can manually switch on and off type PTR 2xx gauges, provided that you have set gauge control to "S-ON HAND".

1. Press the "UP" arrow key for longer than 1 second in order to switch on the gauge.
2. Press the "DOWN" arrow key for longer than 1 second in order to switch off the gauge.

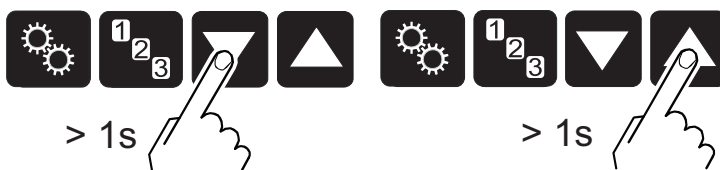

Fig. 33: Switching emission on and off

Switching emission on and off

You can manually switch emission on and off for the type ITR 200 gauges, provided that you have set the gauge parameter to "EMISSION HAND". You can only switch the emission on if the pressure is $< 2.4 \cdot 10^{-2}$ hPa. After switching on, the hot ionization measured value is displayed and the "high-vacuum measuring circuit" symbol lights up.

1. Press the "UP" arrow key for longer than 1 second in order to switch on the emission.
2. Press the "DOWN" arrow key for longer than 1 second in order to switch off the emission.

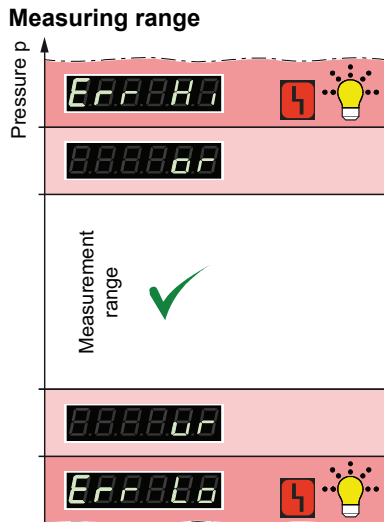

Fig. 34: Measuring range

During operation with linear gauges (CTR, CCR), negative pressure values can be displayed.

Possible causes are:

- Negative drift
- Activated offset correction

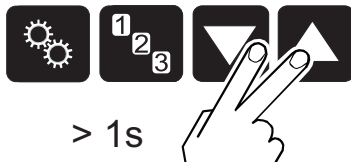

Fig. 35: Identifying the gauge

Identifying the gauge

1. Hold down both arrow keys for longer than 1 second.

The device reads the gauge identification for the current measurement channel and displays this for 6 seconds, for example:

- TTR gauge connected: **TTR**
- No gauge connected: **NO SENSOR**
- Gauge connected but not identifiable: **NO IDENT.**

If you press the "Measurement channel" button during these 6 seconds, the gauge identification of the next measurement channel is also displayed for a further 6 seconds.

7.4 Parameter mode

Parameter mode is the operations mode for displaying and changing/entering parameter values, testing the device and saving measured data. Parameter groups exist for better structuring.

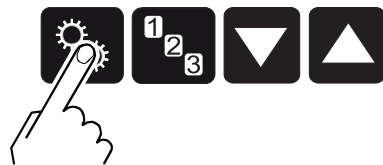

Fig. 36: Change from measuring mode to parameter mode

Parameter groups

- Switching function parameters
- Gauge parameters
- Gauge control



- General parameters
- Test parameters

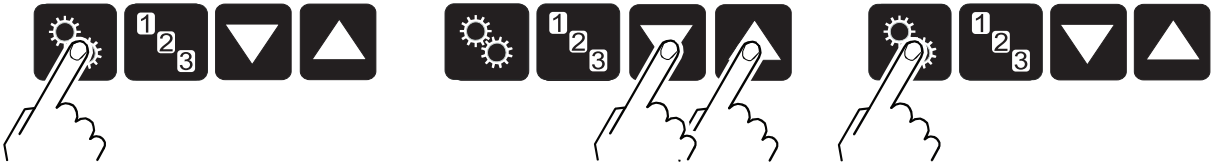

Fig. 37: Change parameters

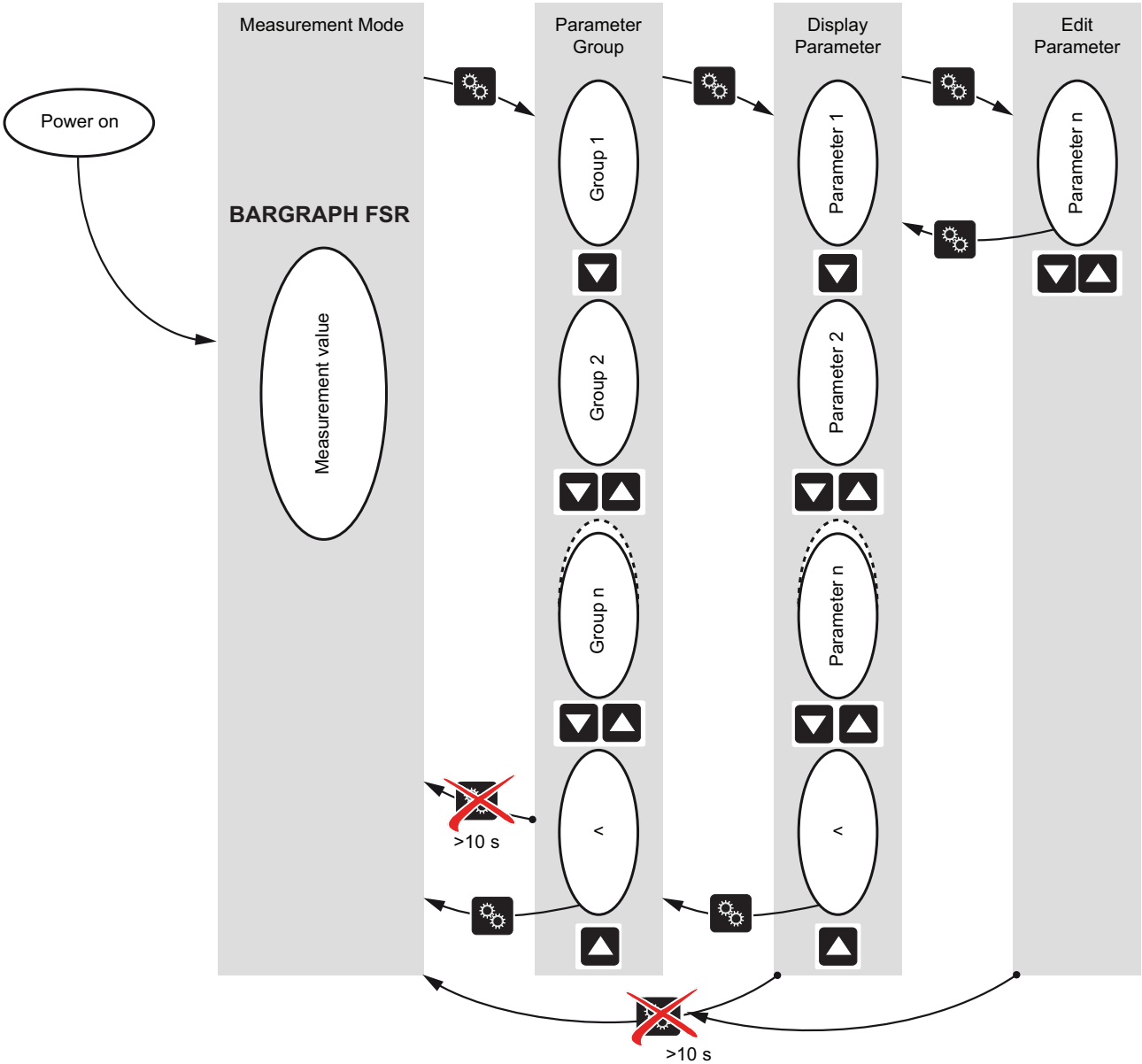

Fig. 38: Read/write parameter groups and parameters (CenterOne)

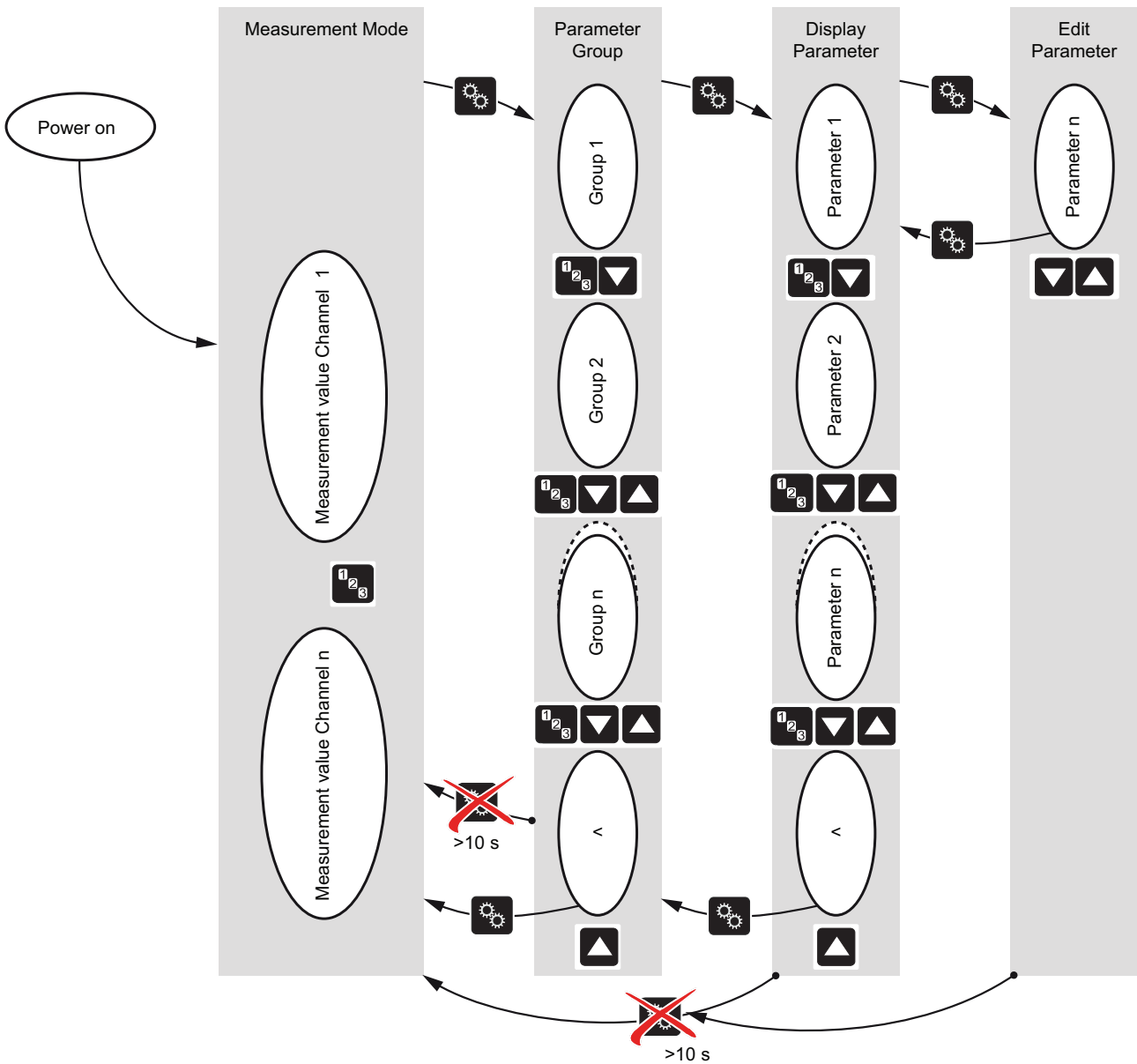

Fig. 39: Read/write parameter groups and parameters (CenterTwo/CenterThree)

Change parameters

1. Press the "Parameter" button to switch to parameter mode.
 - The display shows the respective parameter group instead of the bar graph. The symbol for Parameter mode lights up.
2. Press the "UP" and "DOWN" arrow buttons to select a parameter group.
3. Press the "Parameter" button to confirm the parameter group.
4. Read the parameters of the selected parameter group using the "UP" and "DOWN" arrow buttons.
5. Press the "Parameter" button to confirm the desired parameter.
 - The value flashes and you can now change it.
6. Use the "UP" and "DOWN" arrow buttons to change the value.
7. Press the "Parameter" button to save the change.
 - You then return to read mode.



7.4.1 Switching function parameters

Parameter	Description
SPn-S	Assignment of switch-point n to a measurement channel
SPn-L	Switch-point n: Lower threshold value (setpoint LOW)
SPn-H	Switch-point n: Upper threshold value (setpoint HIGH)

Tbl. 10: Parameters of this group

The switching function parameters group includes displaying and editing/inputting threshold values and assigning switching functions to a measurement channel. The lower and upper threshold value of a switching function always belong to the same channel. The last assignment to be carried out applies for both threshold values.

CenterOne has 2, CenterTwo has 4, and CenterThree has 6 switching functions, each with 2 adjustable threshold values. The states of the switching functions are shown on the display and are available as zero-potential contacts at the "CONTROL" (CenterOne) or "RELAY" (CenterTwo/CenterThree) connection.

The lower threshold value (setpoint low) defines the pressure at which the switching function is switched on if the pressure drops. The upper switching function (setpoint high) defines the pressure at which the switching function is switched off if the pressure rises.



Setting the threshold values

Pfeiffer Vacuum recommends setting the upper threshold value 1/2 decade above the lower threshold value or the lower threshold value 1/2 decade below the upper threshold value.

Display	Description
SP1-S 1	Switching function 1 is assigned to channel 1.
SP1-S 2	Switching function 1 is assigned to channel 2.
SP1-S OFF	Switching function 1 is switched off (factory setting).
SP1-S ON	Switching function 1 is always switched on.
SP1-L 5.00-4	Limit of the lower threshold value (gauge-dependent). If the gauge type changes, the device automatically adjusts the threshold value if necessary.
SP1-H 1500	Limit of upper threshold value (gauge-dependent) If the gauge type changes, the device automatically adjusts the threshold value if necessary.

Tbl. 11: Examples for displays

Gauge type	Lower threshold value [hPa]	Minimum hysteresis	Upper threshold value [hPa]
TTR 9x	2 · 10 ⁻³ 8)	+10% lower threshold value	1000
TTR 101			1500
PTR 91	1 · 10 ⁻⁹		1000
PTR 225/237			1 · 10 ⁻²
ITR 90	1 · 10 ⁻⁸		1000
CCR 36x/37x	F.S. / 1000	+1% measuring range (F.S.)	F.S.

Gas = nitrogen

Tbl. 12: Upper and lower threshold values

8) 2 · 10⁻⁴ hPa with activated RNE-EXT



Minimum hysteresis

The minimum hysteresis between the upper and lower threshold value is a minimum of 10% of the lower threshold value (logarithmic gauges) or 1% of the set upper range value (linear gauges). The upper threshold value is automatically updated with minimum hysteresis if required. This prevents an unstable state.

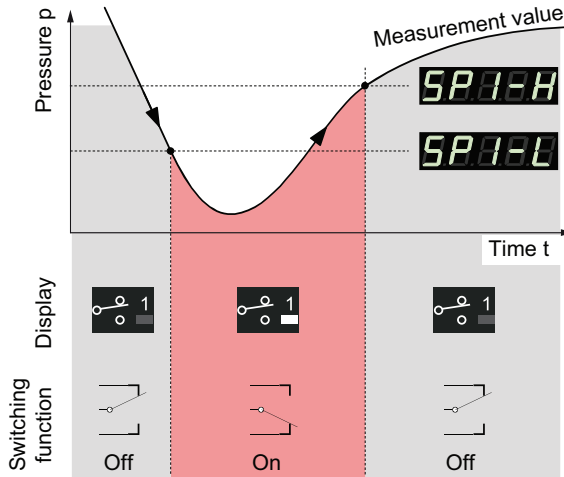

Fig. 40: Switching functions and threshold values

7.4.2 Gauge parameters

Parameter	Description
DEGAS	Clean electrode system
FSR	Measuring range of linear gauges
FILTER	Measured value filter
OFFSET	Offset correction
GAS	Calibration factor for other gas types
COR	Calibration factor
HV-CTRL	Switch high-vacuum measuring circuit on/off
EMISSION	Emission
FILAMENT	Filament
SPACES	Display resolution

Tbl. 13: Parameters of this group

The gauge parameters group includes displaying and editing/inputting gauge-related parameters. Some parameters are not available for all gauges and are thus not always displayed.

Gauge type	TTR 9x	TTR 101	ITR 90	PTR 91	PTR 2xx	CCR 3xx
Parameter						
DEGAS			X			
FSR						X
FILTER	X	X	X	X	X	X
OFFSET						X
GAS	X	X	X	X	X	
COR	X	X	X	X	X	X
HV-CTRL					X	
EMISSION			X			



Gauge type	TTR 9x	TTR 101	ITR 90	PTR 91	PTR 2xx	CCR 3xx
Parameter						
FILAMENT			X			
SPACES	X	X	X	X	X	X

Tbl. 14: Available parameters

DEGAS

Deposits on the electrode system of hot ionization gauges can result in an unstable measured value. Degas enables cleaning of the electrode system by heating the electron collection grid to approx. 700 °C through electron bombardment for 180 seconds (can be switched off prematurely by pressing the "UP" button). The "Degas" display is lit up during this time. Degas is locked in normal operation. You can only run the degas function for pressures $< 7.2 \cdot 10^{-6}$ hPa. The degas function is only effective for the filament that is active in each case.

FSR

With linear analog gauges, you must define their upper range value (Full Scale), whereas the device detects this automatically for linear digital and logarithmic gauges.

FILTER

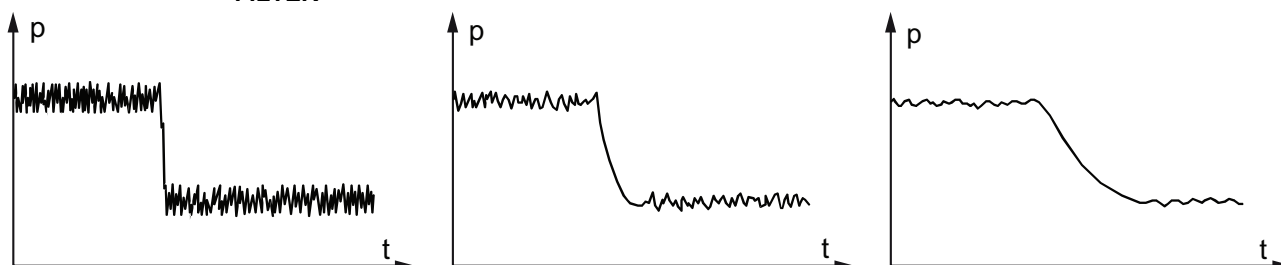

Fig. 41: Fast, normal and slow (from left to right)

The measured value filter permits a better evaluation of measurement signals with fluctuation or interference. The measured value filter does not affect the analog output.

- OFF
 - No measured value filter
- RAPID
 - The device responds rapidly to measured value fluctuations and thus responds to measured value disturbances in an accordingly sensitive manner.
- NORMAL (factory setting)
 - Setting with good ratio between speed of response and sensitivity of display and switching function with respect to measured value changes.
- SLOW
 - The device does not respond to minor measured value fluctuations and thus responds more slowly to measured value changes. Pfeiffer Vacuum recommends this setting for precise comparison measurements.
- CTR (for CCR gauges)
 - The device's response to signal fluctuations depends on the measuring range. The display is particularly stable in the lower range.
 - normal: 0.1 to 1 F.S.
 - slow: 0.04 to 0.1 F.S.
 - approx. 2 × slow: 0.01 to 0.04 F.S.
 - approx. 4 × slow: 0 to 0.01 F.S.

OFFSET

Displays the offset value in the current unit of measure and recalibrates to the current measured value. Offset correction is switched off as the factory setting and affects the measured value display. Offset correction does not affect the threshold value display of the switching functions and the analog outputs at the "control" connection.

If offset correction is enabled, the display lights up and the stored offset value is subtracted from the current measured value. This enables relative measurements with regard to a reference pressure.



Resetting the zero point on the gauges

You must switch off offset correction before you reset the zero point on the gauges.

Zero point calibration of a digital CCR gauge

- ▶ For digital CCR gauges, first adjust the gauge and then the controller.

After zero point calibration, a zero appears on the display. Due to the accuracy of measurement of the CCR gauges (noise, drift etc.), a zero appears with plus/minus several digits.

GAS

The calibration factor GAS permits

- the standardization of the measured value to the non-adjustable gas types nitrogen (N₂), Argon (Ar), Hydrogen (H₂), Helium (He), Neon (Ne), Krypton (Kr) and Xenon (Xe), or
- the manual input of the calibration factor for other gases (parameter COR).

This parameter is not available for the Volt unit of measure.

COR

The calibration factor COR is effective across the entire measuring range and permits the standardization of the measured value to other gas types by a factor of 0.10 to 10.00. A prerequisite is that the "GAS" parameter is set to "COR". The display lights up when COR is switched on.

This parameter is not available for the Volt unit of measure.

HV-CTRL

Switches the high-vacuum measuring circuit on and off.

EMISSION

Switches emission on and off.

- AUTO
 - The gauge switches the emission on and off.
- HAND
 - You can switch the emission on and off manually.

FILAMENT

Selects the filament. When set to "AUTO", the gauge selects one of the two filaments alternately.

SPACES

Resolution of the displayed measured value (decimal places). The factory setting is AUTO, which means that the number of places depends on the connected gauge and the current pressure value.

With TTR gauges, the display is in the pressure range $p < 1.0 \cdot 10^{-4}$ hPa and reduces the activated range expansion by one decimal place.

7.4.3 Gauge control

Parameter	Description
S-ON	Gauge switch-on type
S-OFF	Gauge switch-off type
T-ON (only for CenterTwo/CenterThree)	Switch-on threshold value
T-OFF	Switch-off threshold value

Tbl. 15: Parameters of this group

The gauge control group includes displaying and editing/inputting parameters used to define how gauges are switched on and off. If only gauges without a control option connected, the group is not available.

Some parameters are not available for all gauges and are thus not always displayed.



Gauge type	TTR 9x	TTR 101	ITR 90	PTR 91	PTR 2xx	CCR 3xx
Parameter						
S-ON					X	
S-OFF					X	
T-ON					X	
T-OFF					X	

Tbl. 16: Available parameters

S-ON

You can switch on certain gauges using different switch-on types.

Adjustment, setting	Description
HAND	You can manually switch on the gauges by pressing the “UP” button.
EXTERNAL	You can switch on the gauges via the corresponding control input on the "CONTROL" connection.
HOT START	The gauge switches on automatically when the device is switched on. This allows measuring to continue following a power failure.
S 1 (only for Center-Two/CenterThree)	The gauge on measurement channel n switches the gauge on automatically when the pressure on measurement channel n drops below the switch-on value.
S 2 (only for Center-Two/CenterThree)	You can define a switch-on value using the following T-ON parameter.
S 3 (only for Center-Three)	

Tbl. 17: Switch-on type (S-ON)

S-OFF

You can switch off certain gauges using different switch-off types.

Adjustment, setting	Description
HAND	You can manually switch off the gauge by pressing the “DOWN” button.
EXTERNAL	You can switch off the gauge via the corresponding control input on the "CONTROL" connection.
SELF	Self-monitoring: The gauge switches off automatically if the pressure at the gauge exceeds the switch-off value. You can use the following T-OFF parameter to define a switch-off value.
S 1 (only for Center-Two/Center-Three)	The gauge on measurement channel n switches the gauge off automatically when the pressure on measurement channel n exceeds the switch-off value. You can use the following T-OFF parameter to define a switch-off value.
S 2 (only for Center-Two/Center-Three)	
S 3 (only for Center-Three)	

Tbl. 18: Switch-off type (S-OFF)

T-ON (CenterTwo/CenterThree)

Definition of the switch-on threshold value when using the gauge on the other channel to switch on. The T-OFF value must be \geq T-ON.

This parameter is only displayed if you have set the gauge switch-on type to S-ON S1, S-ON S2 or S-ON S3 (only CenterThree).

T-OFF (CenterOne)

Definition of the switch-off threshold with self-monitoring.

This parameter is only displayed if you have set the gauge switch-off type to S-OFF SELF.

T-OFF (CenterTwo/CenterThree)

Definition of the switch-off threshold value when using the gauge on the other channel to switch off, or for self-monitoring. The T-OFF value must be \geq T-ON.

This parameter is only displayed if you have set the gauge switch-off type to S-OFF S1, S-OFF S2, S-OFF S3 (only CenterThree) or S-OFF SELF.

7.4.4 General parameters

Parameter	Description
UNIT	Unit of measure
BAUD USB	Baud rate of the USB interface
RANGE EXT	Pirani range extension
AO MODE	Logger output
ERR. RELAY	Error relay
BAR GRAPH	Display in bar graph
BACKLIGHT	Background lighting
SCREENSAVER	Screensaver
CONTRAST	Contrast setting
STANDARD	Factory settings
LANGUAGE	Language
FORMAT	Number format of the measured value
END VALUE	Representation of the upper range value

Tbl. 19: Parameters of this group

The general parameters group includes displaying and editing/inputting generally-applicable parameters (system parameters).

Gauge type	TTR 9x	TTR 101	ITR 90	PTR 91	PTR 2xx	CCR 3xx
Parameter						
UNIT	X	X	X	X	X	X
BAUD USB	X	X	X	X	X	X
RANGE EXT	X	X				
AO MODE	X	X	X	X	X	X
ERR. RELAY	X	X	X	X	X	X
BAR GRAPH	X	X	X	X	X	X
BACKLIGHT	X	X	X	X	X	X
SCREENSAVER	X	X	X	X	X	X
CONTRAST	X	X	X	X	X	X
STANDARD	X	X	X	X	X	X
LANGUAGE	X	X	X	X	X	X
FORMAT	X	X	X	X	X	X
END VALUE	X	X	X	X	X	X

Tbl. 20: Available parameters

UNIT

The unit of measure for the measured values, threshold values etc.



- mbar
- hPa (factory setting)
- Torr (only available if the Torr lock is not activated.)
- Pa
- Micron (= 0.001 Torr) (only available if the Torr lock is not activated.)
- Volt

A change to the unit of measure also changes the unit of measure for the ITR 90 and ITR 200 gauges. For CenterOne: If Micron is selected as the unit of measure, it automatically switches to Torr when the level exceeds 99000 Microns. Below 90 Torr, it automatically switches back to the Micron unit of measure.

BAUD USB

Transfer rate of the USB interface.

- 9600, 19200, 38400, 57600 or 115200 baud (factory setting)

RANGE EXT

For TTR gauges with display/measuring range up to $5 \cdot 10^{-5}$ hPa, you can expand the display and switch-point setting area (only acts on the controller). This function is disabled as the factory setting.

- Display and switch-point setting range up to $5 \cdot 10^{-5}$ hPa

AO MODE (CenterTwo/CenterThree)

The logger output is a programmable analog output. The voltage at the logger output is a pressure function on the gauge. The relationship between the pressure and voltage is the output characteristic. Essentially, a distinction is made between logarithmic and linear output characteristics:

- A logarithmic characteristic makes sense if the measurement takes place over many decades of pressure. In this case, the pressure value is logarithmized and then is suitably scaled.
- A linear characteristic makes sense if the measurement spans just a few decades of pressure. In this case, the voltage at the logger output is proportional to the pressure value. You can determine the pressure value at which the maximum voltage is reached.

In the following you will find descriptions of the available output characteristics. In each case, it is specified how you can calculate the pressure p (in hPa) on the basis of the output voltage U (in V). You can press the "Change measurement channel" button to assign the logger output to a specific measurement channel.

- LOG
 - Logarithmic representation of the entire measuring range (factory setting)
 - TTR 9x: $p = 10^{[U/(10/7) - 4]}$
 - TTR 101: $p = 10^{[U/(10/7) - 4]}$
 - ITR 90: $p = 10^{[U/(10/12) - 9]}$
 - PTR 91: $p = 10^{[U/(10/12) - 9]}$
 - PTR 200: $p = 10^{[U/(10/7) - 9]}$
 - CCR 3xx: $p = 10^{[U/(10/4) - 4]} \times FS$
 - Logarithmic representation of the entire measuring range (compatible with A-series)
 - TTR 9x: $p = 10^{[U/(10/6) - 3]}$
 - TTR 101: $p = 10^{[U/(10/7) - 4]}$
 - ITR 90: $p = 10^{[(U - 7.75) / 0.75]}$
 - PTR 91: $p = 10^{[U/(10/11) - 8]}$
 - PTR 200: $p = 10^{[U/(9/7) - 9 - 7/9]}$
 - CCR 3xx: $p = 10^{[U/(10/4) - 4]} \times FS$
- LOG -6
 - Logarithmic representation of a sub-measuring range (2.5 V/decade).
 - $p = 10^{[U/(10/4) - 10]}$
- LOG -3
 - Logarithmic representation of a sub-measuring range (2.5 V/decade).
 - $p = 10^{[U/(10/4) - 7]}$



- LOG +0
 - Logarithmic representation of a sub-measuring range (2.5 V/decade).
 $p = 10^{[U/(10/4) - 4]}$
- LOG +3
 - Logarithmic representation of a sub-measuring range (2.5 V/decade).
 $p = 10^{[U/(10/4) - 1]}$
- LOG C1
 - Logarithmic representation with the following combination:
 TTR at measurement channel 1, PTR 2xx at measurement channel 2
 $p = 10^{[U/(10/12) - 9]}$
- LOG C2
 - Logarithmic representation with the following combination:
 CCR at measurement channel 1 and 2
 This output characteristic only makes sense if the gauges have different measuring ranges.
 The total measuring range targeted by the combination is displayed logarithmically in the range from 0 – 10 V.
- LOG C3
 - Logarithmic representation with the following combination:
 CCR on measurement channel 1, 2 and 3
 This output characteristic only makes sense if the gauges have different measuring ranges.
 The total measuring range targeted by the combination is displayed logarithmically in the range from 0 – 10 V.
 The three gauges must be sorted with regard to the upper range value (FS). The sorting sequence can be ascending or descending.
- LOG LIN -10 to LIN +3
 - Linear representation:
 LIN -10: U = 10 V equates to $p = 10^{-10}$ hPa.
 LIN -10: $p = U/10 \cdot 10^{-10}$
 LIN +3: U = 10 V equates to $p = 10^{+3}$ hPa.
 LIN +3: $p = U/10 \cdot 10^{+3}$
 Adjustable from LIN -10 to LIN +3
- IM221
 - Logarithmic representation IM221 Controller (1 V/decade):
 U = 8 V equates to $p = 10^{-2}$ hPa
 $p = 10^{[U - 10]}$
- LOG C4
 - Logarithmic representation over 12 decades (0.83 V/decade) with the following combination:
 TTR 101 at measurement channel 1, ITR 200 at measurement channel 2
 U = 10 V equates to $p = 1000$ hPa. The switch-point between the gauges is 10^{-2} hPa.
 $p = 10^{[U/(10/12) - 9]}$
- PM411
 - Non-linear output characteristics such as with the PM411 plug-in card.
- CH X
 - Output voltage = input voltage sensor
- PRM10K
 - Non-linear output characteristics such as with Edwards PRM10K gauges
- IMR110
 - Logarithmic representation compatible with IMR110 gauges, $p = 10^{[U/2 - 6]}$
- IMR120
 - Logarithmic representation compatible with IMR120 gauges, $p = 10^{[U/2 - 8]}$
- IMR310
 - Logarithmic representation compatible with IMR310 gauges, $p = 10^{[U*6/10 - 6]}$
- IMR320
 - Logarithmic representation compatible with IMR320 gauges, $p = 10^{[U*7/10 - 9]}$



- PRL10K
 - Non-linear output characteristics such as with Edwards PRL10K gauges
- PRL1Q
 - Non-linear output characteristics such as with Edwards PRL1Q gauges

Sorting the gauges (with LOG C3)

- ▶ Sort the three gauges with regard to the upper range value (FS).
 - The sorting sequence can be ascending or descending.

ERR. RELAY

The switching behavior of the error relay.

- ALL
 - Switches with all errors (factory setting)
- No SE
 - Only device error
- S 1
 - Error sensor 1 and device error
- S 2
 - (CenterTwo/CenterThree)
 - Error sensor 2 and device error
- S 3
 - (CenterTwo/CenterThree)
 - Error sensor 3 and device error

BAR GRAPH

A bar graph of the measured pressure as a function of time ($p = f_{(t)}$) can be shown on the display. During parameter setting, the parameter and the parameter value are displayed here.

- OFF
 - Disabled (factory setting)
- FSR
 - Bar graph over entire measuring range of gauge
- FSR h
 - Bar graph over entire measuring range of gauge, high representation
- FSR+SP
 - over entire measuring range of gauge and switch-point threshold value
- DEC
 - Bar graph over one decade in accordance with current measured value
- DEC h
 - Bar graph over one decade in accordance with current measured value, high representation
- DEC+SP
 - Bar graph over one decade in accordance with current measured value and switch-point threshold value
- f(0.2s)
 - $p = f_{(t)}$, auto-scaled, 0.2 seconds/pixel
 - The device stores a measured value in tabular form every 200 ms for each measurement channel, and shows the last 100 measured values (= 100 pixel) auto-sized. The illustrated data series corresponds with a recording duration of 20 seconds.
- f(1s)
 - $p = f_{(t)}$, auto-scaled, 1 second/pixel
 - The device stores a measured value in tabular form every second for each measurement channel, and shows the last 100 measured values (= 100 pixel) auto-sized. The illustrated data series corresponds with a recording duration of 100 seconds.
- f(6s)
 - $p = f_{(t)}$, auto-scaled, 6 seconds/pixel
 - The device stores a measured value in tabular form every 6 seconds for each measurement channel, and shows the last 100 measured values (= 100 pixel) auto-sized. The illustrated data series is equivalent to a recording duration of 10 minutes.



- f(1min)
 - $p = f_{(t)}$, auto-scaled, 1 minute/pixel
 - The device stores a measured value in tabular form every minute for each measurement channel, and shows the last 100 measured values (= 100 pixel) auto-sized. The illustrated data series is equivalent to a recording duration of 100 minutes.
- f(0.5h)
 - $p = f_{(t)}$, auto-scaled, 30 minutes/pixel
 - The device stores a measured value in tabular form every 30 minutes for each measurement channel, and shows the last 100 measured values (= 100 pixel) auto-sized. The illustrated data series is equivalent to a recording duration of 50 hours.
- IDENT
 - The device displays the gauge type, e.g. TTR, for the selected measurement channel.

BACKLIGHT

The value for the backlight is adjustable from 0 to 100 % (full brightness).

- 0 to 100 % (ex factory = 60 %)

SCREENSAVER

The screensaver is disabled as the factory setting. The screensaver can be set for different time periods.

Choosing the "DR" (Darkroom) setting, switches off the backlight completely after 1 minute. You can press any key to reactivate the backlight.

- Off (ex factory), 10 minutes, 30 minutes, 1 hour, 2 hours, 8 hours or DR

CONTRAST

The value for the contrast is adjustable from 0 to 100 % (full contrast).

- 0 to 100 % (ex factory = 40 %)

STANDARD

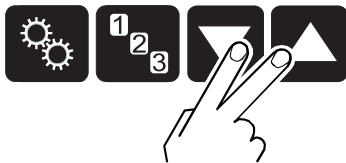

Fig. 42: Press the arrow keys simultaneously > 2 seconds

Reset all the parameters set/changed by the user to the default values (factory settings). **Once you have loaded the default parameters you cannot undo this step.** To load the factory settings, press the "UP" and "DOWN" keys simultaneously. "OK" is then displayed.

LANGUAGE

The language of the display.

- English (factory setting)
- German
- French

FORMAT

The numeric format of the measured value output in floating decimal or exponential format. If a measured value cannot be illustrated meaningfully in floating decimal format, it is automatically displayed in exponential format.

- X.X (floating decimal number, if displayable (ex factory))
- X.XESY (exponential illustration)

END VALUE

The display in case of undershooting or exceeding the measuring range.



- UR/OR (UR or OR displayed (ex factory))
- VALUE (the respective measuring range end value is displayed.)
- </> VALUE (the respective upper range value and "<" or ">" is displayed.)
The "<" symbol stands for the degree of the measuring range undershoot.
< = 0.1 % F.S. / << = 0.2 % F.S. / <<< = 0.3 % F.S.

7.4.5 Test parameters

Parameter	Description
SOFTWARE	Firmware version
HARDWARE	Hardware version
MAC	MAC address
HOURS	Operating hours
WATCHDOG	Watchdog error behavior
TORR LOCK	Torr lock
KEY LOCK	Key lock
FLASH	FLASH test (program memory)
EEPROM	EEPROM test (parameter memory)
DISPLAY	Display test
I/O	I/O test
CALIB	Re-calibration

Tbl. 21: Parameters of this group

The test parameters group includes displaying the firmware version, editing/inputting special parameter values, and the test programs. The parameters in this group are available with all gauges.

The group is only available if

- you press the "Parameter" button when switching the device on, or
- press the  "Parameter" button for 5 seconds on the display.

SOFTWARE

Firmware version (program version) display.

This information is useful if you need to contact Pfeiffer Vacuum.

HARDWARE

Hardware version display.

This information is useful if you need to contact Pfeiffer Vacuum.

MAC

Displays the MAC address (without separator).

Example: 00-A0-41-0A-00-08 is displayed as 00A0410A0008.

HOURS

Operating hours display.

WATCHDOG

Behavior of system monitoring (Watchdog Control) in the event of an error.

- AUTO
 - The system acknowledges a Watchdog malfunction message itself after 2 seconds (factory setting).
- OFF
 - The user must acknowledge a Watchdog malfunction message.

TORR LOCK

Suppression of the Torr unit of measure as a parameter value during setting. This function is disabled in the factory setting.

KEY LOCK

The key lock prevents unintentional input in parameter mode and thus any malfunctions. This function is disabled in the factory setting.

FLASH

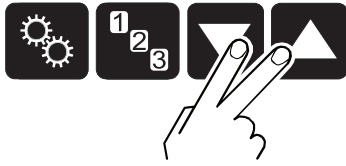

Fig. 43: Program memory test

Program memory test.

- **RUNNING**
 - The test is running (very short).
- **OK**
 - Test completed, no errors detected. An 8-digit checksum is then displayed, for example FLASH 0x12345678.
- **ERROR**
 - Test completed, errors detected. An 8-digit checksum is then displayed, for example FLASH 0x12345678.

If the error occurs again when the test is repeated, you should contact your nearest Pfeiffer Vacuum Service Center.

EEPROM

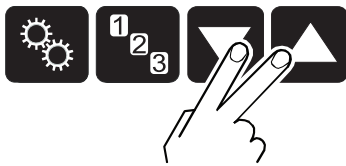

Fig. 44: Parameter memory test

Parameter memory test.

- **RUNNING**
 - The test is running.
- **OK**
 - Test completed, no errors detected.
- **ERROR**
 - Test completed, errors detected.

If the error occurs again when the test is repeated, you should contact your nearest Pfeiffer Vacuum Service Center.

DISPLAY

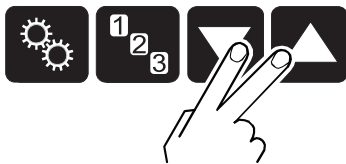

Fig. 45: Display test

Display test.

After starting the test, all the display elements light up simultaneously for 10 seconds.



I/O

NOTICE**Unintentional results with controller connected**

Switch relay not dependent on pressure. Values below the intended measuring range, or starting the test program, can result in unintentional results at the connected controller, if the relay switches.

- ▶ Unplug the connected measuring and control cable.
- ▶ Prevent triggering of incorrect control commands or messages.

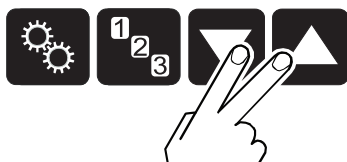

Fig. 46: Test of relays in the device

Test of relays in the device. The test program tests the relays' switching function.

The relays switch on and off cyclically. The display visually indicates the switching operations. The switching operations also emit a clearly audible sound. The contacts of the switching functions are available at the "CONTROL" (CenterOne) or "RELAY" (CenterTwo/CenterThree) connection on the rear side of the device. You can use an ohmmeter to check the function.

- OFF
 - All relays switched off
- RELn
 - Relay switching function n

CALIB

Date of next recalibration. When the set date is reached, a "RECALIB REQUIRED" message is displayed.

7.5 Data logger mode

Parameter	Description
DATE	Current date
TIME	Current time
INTERVAL	Interval of measured data recording
DECIMAL POINT	Decimal separator
FILE NAME	File name
START/STOP	Start/stop recording
DELETE	Deletion of files with recorded measured data

Tbl. 22: Parameters of this group

The data logger group includes

- logging measured data onto a USB memory stick (USB interface type A).
- deleting recorded measured data from the USB memory stick.

The group is only available if a USB memory stick (≤ 32 GB) formatted with the FAT file system (FAT32) is plugged in.

**USB memory sticks**

The device does not recognize all USB memory sticks, for instance if they do not comply with the USB standard. Try using a different memory stick first before you contact your nearest Pfeiffer Vacuum Service Center.

DATE

Current date in format YYYY-MM-DD.

TIME

Current time in format hh:mm [24 h].

INTERVAL

Interval of measured data recording.

- 1 s
 - Recording interval 1/s
- 10 s
 - Recording interval 1/10 s
- 30 s
 - Recording interval 1/30 s
- 1 min
 - Recording interval 1/60 s
- 1 %
 - Recording interval: With measured value changes $\geq 1\%$
- 5 %
 - Recording interval: With measured value changes $\geq 5\%$

DECIMAL POINT

Decimal point for the measured values with measured data recording (full stop or comma).

The decimal separator is important for further processing with a spreadsheet program.

FILE NAME

Name of the measured data file max. 7 characters. The file extension is CSV.

If the name is shorter than 7 characters, the device requires a space character for the remaining characters. After entering the 7th character, the display stops flashing. The device has stored the name and reverted to read mode.

START/STOP

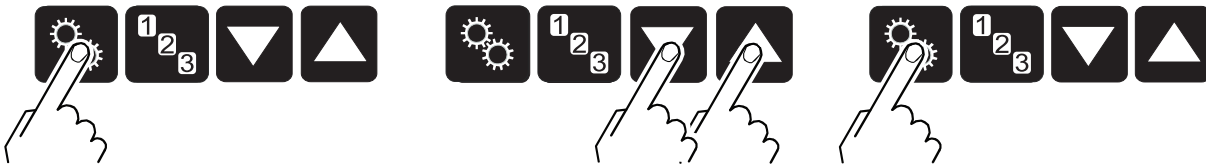

Fig. 47: Start/stop measured data recording

Start/stop measured data recording.

During measured data recording, "Parameter mode" flashes (only in measuring mode).

"UP" button = start saving. Recording is running, the display switches to "STOP" and the "DOWN" arrow flashes.

"DOWN" button = stop saving. Recording stops, the display switches to "START" and the "UP" arrow flashes.

If the arrows are flashing on the display, the device does not automatically revert to measuring mode. You can press the "Parameter" button to quit write mode. The device then automatically reverts to measuring mode after approx. 10 seconds.

DELETE

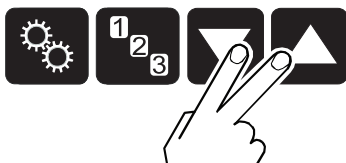

Fig. 48: Delete files

Delete all measured data files (with CSV file extension) from the USB memory stick.

- RUNNING
 - CSV files are being deleted.
- DONE
 - CSV files have been deleted.



7.6 Setup mode

Parameter	Description
SAVE	Save all parameters
RESTORE	Write all parameters to the device
FORMAT	Format the USB memory stick (FAT32)
DELETE	Delete files with stored parameters

Tbl. 23: Parameters of this group

This group allows

- all parameters to be saved on a USB memory stick (USB interface type A).
- all parameters to be loaded from a USB memory stick onto the device.
- the formatting of a USB memory stick.
- the deletion of files with stored parameters from the USB memory stick.

The group is only available if a USB memory stick (≤ 32 GB) formatted with the FAT file system (FAT32) is plugged in.

SAVE

Save all the device's parameters on a USB memory stick (file: SETUPxx.CSV). The device saves the threshold values and the offset in the unit of measure mbar or hPa.

You can choose the file names from SETUP01 to SETUP99.

- RUNNING
 - The device saves the CSV file.
- DONE
 - The save operation is complete.

RESTORE

Load all parameters from a USB memory stick onto the device. If you have not specified a unit of measure in the CSV file for the threshold values and the offset, the device loads the values in mbar or hPa. Otherwise, the device explicitly requires a unit of measure in upper case letters for these values (MBAR, HPASCAL, TORR, PASCAL, or MICRON) followed by a space character, e.g. 5.00-4 TORR or 0.0002 PASCAL.

You can choose the file names from SETUP01 to SETUP99.

- RUNNING
 - The device loads the CSV file.
- DONE
 - Loading is complete.
- ERROR
 - An error has occurred.

FORMAT

Format the USB memory stick.

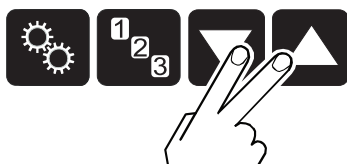

Fig. 49: Formatting the USB memory stick

- RUNNING
 - Formatting is running.
- DONE
 - Formatting is complete.

DELETE

Delete all parameter files (ending with CSV) from the USB memory stick.

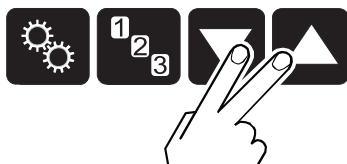

Fig. 50: Delete parameter files from the USB memory stick

- RUNNING
 - The device is deleting the files.
- DONE
 - The device has deleted the files.



8 Decommissioning

Switching the device off

1. Switch off the device at the mains switch.
2. **For rack assembly:** Switch off the device centrally via the switched mains distributor.
3. Wait at least 10 seconds before switching it back on again, so that the device can reinitialize.

9 Maintenance



Maintenance in the Pfeiffer Vacuum Service Center

Pfeiffer Vacuum offers a complete maintenance service for all products.

Pfeiffer Vacuum recommends: Contact your Pfeiffer Vacuum Service Center to arrange the maintenance of defective products and components.



Cleaning in the Pfeiffer Vacuum Service Center

Pfeiffer Vacuum recommends: Contact your nearest Pfeiffer Vacuum Service Center to arrange the cleaning of heavily-soiled products and components.



Loss of warranty claims

The following will result in the loss of the warranty:

- Damage to or removal of a closure seal
- Opening the device during the warranty period

Contact the Pfeiffer Vacuum Service Center in the event of process-related shorter maintenance intervals.



First read through the sections completely

Read the section with the work instructions through completely first before you commence with work.

9.1 Cleaning the device

⚠ DANGER

Electric shocks due to moisture penetrating into the device

Moisture that has penetrated into the device results in personal injury through electric shocks.

- ▶ Only operate the device in a dry environment.
- ▶ Operate the device away from fluids and humidity sources.
- ▶ Do not switch on the device if fluid has penetrated into it, instead contact Pfeiffer Vacuum Service.
- ▶ Always disconnect the current supply before cleaning the device.

⚠ WARNING

Health hazards due to cleaning agent

The cleaning agents used cause health hazards.

- ▶ When handling cleaning agents, observe the applicable regulations.
- ▶ Adhere to safety measures regarding handling and disposal of cleaning agents.
- ▶ Be aware of potential reactions with product materials.

NOTICE

Damage caused by penetrating moisture

Penetrating moisture, e.g. through condensation or dripping water, damages the device.

- ▶ Protect the device against moisture penetrating.
- ▶ Only operate the device in a clean and dry environment.
- ▶ Operate the device away from fluids and humidity sources.
- ▶ Take special precautions if there is a risk of dripping water.
- ▶ Do not switch on the device if fluid has penetrated into it, instead contact the Pfeiffer Vacuum Service Center.



NOTICE**Damage caused by unsuitable cleaning agents**

Unsuitable cleaning agents damage the product.

- ▶ Do not use solvents as they attack the surface.
- ▶ Do not use any aggressive or abrasive cleaning agents.

Cleaning the device**Required consumables**

- Common cleaning agent (e.g. mild detergent).
 - Soft cloth
1. Switch the device off and disconnect it from the network.
 2. Use a soft, damp cloth to clean the surfaces.
 3. Allow the surfaces to dry thoroughly after cleaning.

9.2 Replacing the battery

The product contains a battery (type CR2032, service life > 10 years), in order to maintain the data integrity of the real-time clock. A battery replacement is necessary if the real-time clock repeatedly displays an incorrect date. To arrange for the battery to be replaced, you must contact your nearest Pfeiffer Vacuum Service Center.



10 Malfunctions

The error appears and the error relay opens.



The malfunction cannot be eliminated

If the malfunction persists even after acknowledging several times and/or replacing the gauges, please contact your nearest Pfeiffer Vacuum Service Center.

Error	Possible cause	Correction/acknowledgment
Display: SENSOR ERROR	Interruption or malfunction in the connection to the gauge (sensor error).	Press the "Parameter" button to acknowledge.
Display: WATCH-DOG ERROR	The device has been switched back on too quickly after being switched off.	Press the "Parameter" button to acknowledge.
	The watchdog has responded as a result of a severe electrical malfunction or operating system error.	If the Watchdog is set to Auto, the device automatically acknowledges after 2 seconds.
Display: DATA CORRUPT	Parameter memory error (EEPROM).	Press the "Parameter" button to acknowledge.

Tbl. 24: Malfunctions



11 Shipping

WARNING

Risk of poisoning from contaminated products

Where products that contain harmful substances are shipped for maintenance or repair purposes, the safety of service personnel is at risk.

- ▶ Comply with the instructions for safe shipping.

Shipping the product safely



Decontamination subject to charge

Pfeiffer Vacuum decontaminates products not clearly declared "Free of contamination" at your expense.

1. Do not ship microbiological, explosive or radioactively contaminated products.
2. Observe the shipping guidelines for the participating countries and transport companies.
3. Highlight any potential dangers on the outside of the packaging.
4. Download the declaration of contamination. ([Pfeiffer Vacuum Service](#)).
5. Always enclose a completed declaration of contamination.



12 Disposal

⚠ WARNING

Health hazard through poisoning from toxic contaminated components or devices

Toxic process media result in contamination of devices or parts of them. During maintenance work, there is a risk to health from contact with these poisonous substances. Illegal disposal of toxic substances causes environmental damage.

- ▶ Take suitable safety precautions and prevent health hazards or environmental pollution by toxic process media.
- ▶ Decontaminate affected parts before carrying out maintenance work.
- ▶ Wear protective equipment.

⚠ CAUTION

Health hazard caused by environmentally hazardous substances

Products, operating fluid, electric components, calibration gas residues (for example from test leaks) or similar pose health hazards.

- ▶ Dispose of the environmentally hazardous substances in accordance with local regulations.
- ▶ Dispose of calibration gas and test leaks in accordance with local regulations.

Dividing components

- ▶ After disassembly, divide the components into the following categories with regard to disposal:
 - contaminated components **that have** contact with process gases
 - non-contaminated components **that have no** contact with process gases

Disposal of contaminated components that have contact with process gases

1. Dispose of the substances in a safe manner in accordance with the locally applicable regulations if the process gases used were contaminated, e.g. radioactive, toxic, caustic or a microbiological manner.
2. Observe the environment and safety provisions of the respective country.

Disposal of components that do not have contact with process gases

1. Separate the components according to their type of material:
 - electronic components
 - electrical components
 - battery and rechargeable batteries
 - mechanical components
2. Recycle the components.
3. Dispose of the substances in a safe manner according to locally applicable regulations.
4. Observe the environment and safety provisions of the respective country.



13 Service solutions from Pfeiffer Vacuum

We offer first class service

Long vacuum component service life, coupled with low downtimes, are clear expectations that you have of us. We satisfy your needs with capable products and outstanding service.

We are consistently striving to perfect our core competence, service for vacuum components. And our service is far from over once you've purchased a product from Pfeiffer Vacuum. It often enough really just begins then. In proven Pfeiffer Vacuum quality, of course.

Our professional sales engineers and service technicians stand ready to provide hands-on support to you worldwide. Pfeiffer Vacuum offers a complete portfolio of service offerings, ranging from genuine spare parts right through to service agreements.

Take advantage of Pfeiffer Vacuum Service

Whether for preventative on-site service from our field service, fast replacement with as-new replacement products or repair in a Service Center close to you; you have various options for upholding your equipment availability. Detailed information and addresses can be found on our website in the Pfeiffer Vacuum Service section.

Advice on the optimum solution is available from your Pfeiffer Vacuum contact partner.

For quick and smooth handling of the service process, we recommend the following steps:



1. Download the current form templates.
 - [Declaration of Service Request](#)
 - [Service Request](#)
 - [Declaration of Contamination](#)



- a) Dismantle all accessories and keep them (all external mounted parts as valve, inlet screen, etc.).
 - b) Drain the operating fluid/lubricant as necessary.
 - c) Drain the cooling medium as necessary.
2. Fill out the service request and the declaration of contamination.



3. Send the forms via email, fax or post to your local Service Center.



4. You will receive a response from Pfeiffer Vacuum.

PFEIFFER VACUUM

Sending of contaminated products

No units will be accepted if they are contaminated with micro-biological, explosive or radioactive substances. If products are contaminated or if the declaration of contamination is missing, Pfeiffer Vacuum will contact the customer before starting maintenance. In addition, depending on the product and the level of contamination **additional decontamination costs** may be required.



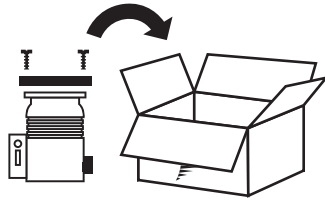

5. Prepare the product for transport in accordance with the details in the declaration of contamination.
 - a) Neutralize the product with nitrogen or dry air.
 - b) Close all openings with airtight blank flanges.
 - c) Seal the product in appropriate protective film.
 - d) Only pack the product in suitable, stable transport containers.
 - e) Observe the applicable transport conditions.

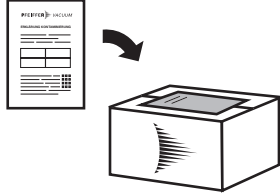

6. Affix the declaration of contamination to the **outside** of the packaging.

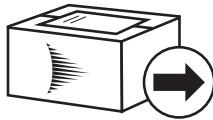

7. Then send your product to your local Service Center.

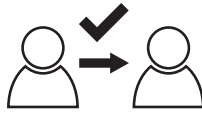

8. You will receive a confirmation message/a quotation from Pfeiffer Vacuum.

PFEIFFER VACUUM

For all service orders, our General Terms and Conditions of Sales and Supply and General Terms and Conditions of Repair and Maintenance apply to vacuum equipment and components.



14 Ordering information

14.1 Ordering parts

Ordering spare parts, accessories or optional components

- ▶ Always specify the following details when ordering spare parts, accessories or optional components:
 - all details according to the rating plate
 - description and order number according to the parts list

14.2 Accessories

Description	order number
Adapter plate for installation in rack modules with 3 height units	PT 441 482

15 Technical data and dimensions

15.1 Technical data

General

Parameter	Value
Use	For rack installation, control panel installation or as a tabletop device
Weight	0.85 kg (CenterOne) 1.10 kg (CenterTwo) 1.14 kg (CenterThree)

Tbl. 25: General

Mains power supply

Parameter	Value
Voltage	100 – 240 V (AC) $\pm 10\%$
Frequency	50 – 60 Hz
Power input	≤ 45 W (CenterOne) ≤ 65 W (CenterTwo) ≤ 90 W (CenterThree)
Excess voltage category	II
Protection class	1
Connection	(see chapter "Mains power supply", page 22)

Tbl. 26: Mains power supply

Ambient conditions

Parameter	Value
Storage temperature, max.	-20 – 60 °C
Operating temperature, max.	5 – 50 °C
Relative humidity	$\leq 80\%$ to +31 °C, decreasing to 50 % at +40 °C
Use	Only in indoor areas
Installation altitude max.	2000 m NN
Degree of contamination	II
Protection system, class, category	IP30

Tbl. 27: Ambient conditions

Gauge connections

Parameter	Value
Quantity, number	1 (CenterOne) 2 (CenterTwo) 3 (CenterThree)
Connection	(see chapter "'CH" connection (channel)", page 23)
Connectable gauges:	
	TTR 90, TTR 211 S, TTR 91, TTR 91 S, TTR 96 S, TTR 211, TTR 216, TTR 911, TTR 911 CC, TTR 916
	TTR 100, TTR 100 S2, TTR 101, TTR 101 S2
	PTR 225, PTR 225 S, PTR 237
	PTR 90, PTR 91



Parameter	Value
ITR 90, ITR 200	
CTR 90, CTR 91, CTR 100, CTR 101, CCR 36x, CCR 37x, DI/DU 200, DI/DU 201, DI/DU 2000, DI/DU 2001, DI/DU 2001 rel	

Tbl. 28: Gauge connections
Gauge supply voltage

Parameter	Value
Voltage	+24 V (DC) ± 5 %
Ripple	$< \pm 1$ %
Current	0 – 1 A (per channel)
Power	25 W (per channel)
Fuse	1.5 A (per channel) with PTC element, self-resetting after switching off the device or unplugging the gauge plug. The voltage supply meets the requirements of an protected extra-low voltage.

Tbl. 29: Gauge supply voltage
Operation

Parameter	Value
Front panel	3 Controls (CenterOne) 4 Controls (CenterTwo/CenterThree)
Remote control	USB type B interface, Ethernet interface

Tbl. 30: Operation
Measured values

Parameter	Value
Measuring ranges	Gauge-dependent
Measuring error (amplification error)	≤ 0.01 % F.S. (typical), ≤ 0.10 % F.S. (over temperature range, time)
Measuring error (offset error)	≤ 0.01 % F.S. (typical), ≤ 0.10 % F.S. (over temperature range, time)
Measuring rate analog	≥ 100 / s
Display rate	≥ 10 / s
Filter time constant (slow)	8 s ($f_g = 0.02$ Hz)
Filter time constant (normal)	800 ms ($f_g = 0.2$ Hz)
Filter time constant (fast)	160 ms ($f_g = 1$ Hz)
Unit of measure	mBar, hPa, Torr, Pa, Micron, V
Offset correction	for linear gauges
Calibration factor	0.10 – 10.00
A/D conversion	Resolution 0.001 % F.S. ⁹⁾

Tbl. 31: Measured values
Switching functions

Parameter	Value
Quantity, number	2 (CenterOne) 4 (assign freely) (CenterTwo) 6 (assign freely) (CenterThree)
Response time	≤ 10 ms, if the threshold value is near the measured value (note the filter time constant if there is a large difference).

9) The measured values of ITR, CTR 100, CTR 101, CCR 36x and CCR 37x are transferred digitally.



Parameter	Value
Setting range	Gauge-dependent
Hysteresis	≥ 1 % F.S. for linear gauges, ≥ 10 % of the measured value for logarithmic gauges

Tbl. 32: Switching functions

Switching function relay

Parameter	Value
Contact type	Zero-potential two-way contact
Load max.	60 V (DC), 0.5 A, 30 W (ohmic) 30 V (AC), 1 A (ohmic)
Service life (mechanical)	1 · 10 ⁸ Switching cycles
Service life (electrical)	1 · 10 ⁵ Duty cycles (at maximum load)
Contact settings	(see chapter "CONTROL" connection (CenterOne)", page 24)
Connection	(see chapter "RELAY" connection (only CenterTwo/Center-Three)", page 25)

Tbl. 33: Switching function relay

Error signal (error)

Parameter	Value
Quantity, number	1
Response time	≤ 10 ms

Tbl. 34: Error signal (error)

Error signal relay

Parameter	Value
Contact type	Zero-potential two-way contact
Load max.	60 V (DC), 0.5 A, 30 W (ohmic) 30 V (AC), 1 A (ohmic)
Service life (mechanical)	1 · 10 ⁸ Switching cycles
Service life (electrical)	1 · 10 ⁵ Duty cycles (at maximum load)
Contact settings	(see chapter "CONTROL" connection (CenterOne)", page 24)
Connection	(see chapter "RELAY" connection (only CenterTwo/Center-Three)", page 25)

Tbl. 35: Error signal relay

Gauge control

Parameter	Value
Switch on/off automatically	Switch on/off threshold value adjustable (see chapter "Gauge control", page 46)
Switch on/off via buttons	(see chapter "Measuring mode", page 38)
Switch on/off via "CONTROL" connection	Switch-on criterion: Signal ≤ +0.8 V (DC) Switch-off criterion: Signal +2.0 – 5 V (DC) or input open (see chapter "CONTROL" connection (CenterOne)", page 24) (see chapter "CONTROL" connection (CenterTwo/Center-Three)", page 25)



Parameter	Value
switch on with mains voltage	(see chapter "Gauge control", page 46)
with pressure rise	Switch-off threshold value adjustable (see chapter "Gauge control", page 46)

Tbl. 36: Gauge control
Analog output

Parameter	Value
Quantity, number	1 (CenterOne) 2 (1 per channel) (CenterTwo) 3 (1 per channel) (CenterThree)
Voltage range	-5 – +14.5 V (DC) ¹⁰⁾
Deviation from the display value	± 20 mV
Output resistance	< 50 Ω
Measurement signal to pressure ratio	Gauge-dependent
Connection	(see chapter "'CONTROL" connection (CenterOne)", page 24) (see chapter "'CONTROL" connection (CenterTwo/Center-Three)", page 25)

Tbl. 37: Analog output
Logger output (CenterTwo/CenterThree)

Parameter	Value
Quantity, number	1
Voltage range	0 – +10 V (DC)
Resolution	1 mV
Precision	± 20 mV
Internal resistance	< 50 Ω
Measurement signal to pressure ratio	programmable
Connection	(see chapter "'CONTROL" connection (CenterTwo/Center-Three)", page 25)

Tbl. 38: Logger output
USB interface (type A)

Parameter	Value
Log	FAT file system File processing in ASCII format

Tbl. 39: USB interface (type A)
USB interface (type B)

Parameter	Value
Log	ACK/NAK, ASCII with 3 character mnemonics
Data format	Two-way data traffic, 1 start bit, 8 data bits, 1 stop bit, no parity bit, no handshake
Baudrate	9600, 19200, 38400, 57600, 115200

Tbl. 40: USB interface (type B)

10) If no gauge is connected, +14.5 V (DC) is output.

Ethernet interface

Parameter	Value
Log	ACK/NAK, ASCII with 3 character mnemonics
Data format	Two-way data traffic, 1 start bit, 8 data bits, 1 stop bit, no parity bit, no handshake
Baudrate	9600, 19200, 38400, 57600, 115200
IP address	DHCP (factory setting) or manual input
MAC address	readable via "MAC" parameter

Tbl. 41: Ethernet interface

15.2 Dimensions

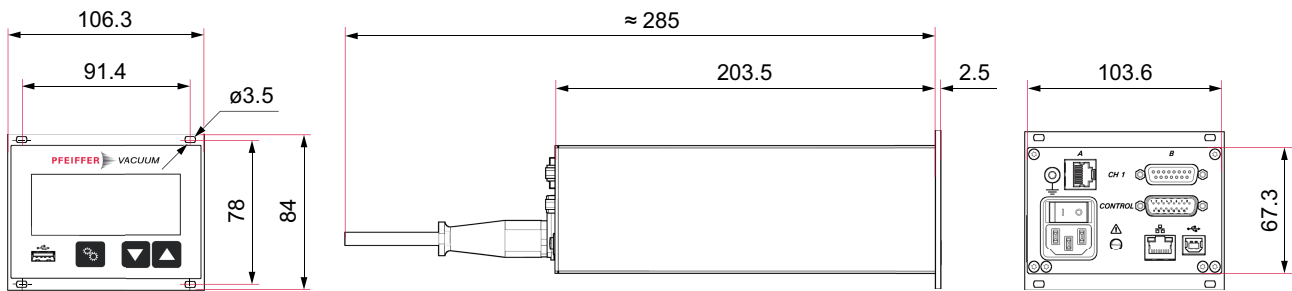

Fig. 51: Dimensions CenterOne (in mm)

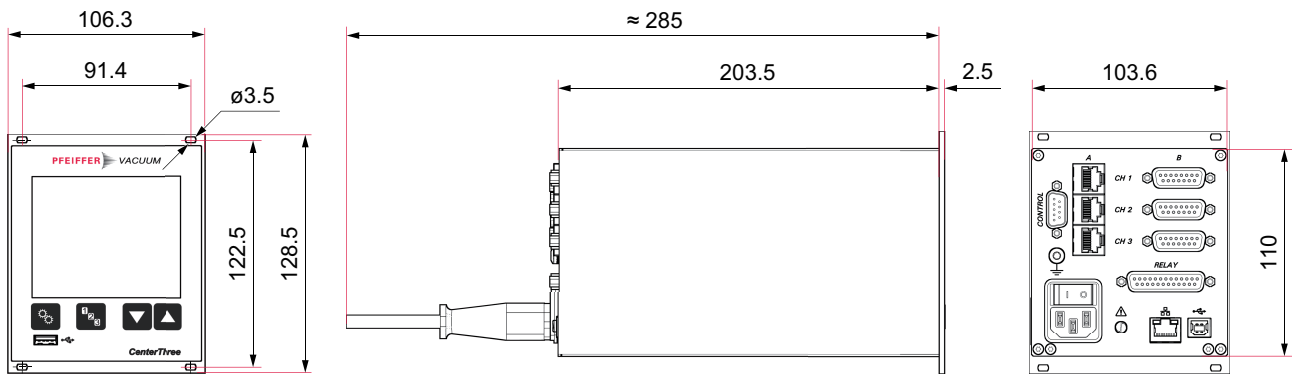

Fig. 52: Dimensions CenterTwo and CenterThree (in mm)



16 Appendix

16.1 Units of pressure

Unit	mbar	bar	Pa	hPa	kPa	Torr / mm Hg
mbar	1	$1 \cdot 10^{-3}$	100	1	0.1	0.75
bar	1000	1	$1 \cdot 10^5$	1000	100	750
Pa	0.01	$1 \cdot 10^{-5}$	1	0.01	$1 \cdot 10^{-3}$	$7.5 \cdot 10^{-3}$
hPa	1	$1 \cdot 10^{-3}$	100	1	0.1	0.75
kPa	10	0.01	1000	10	1	7.5
Torr / mm Hg	1.33	$1.33 \cdot 10^{-3}$	133.32	1.33	0.133	1

1 Pa = 1 N/m²

Tbl. 42: Units of pressure and their conversion

16.2 Gas throughputs

Unit	mbar l/s	Pa m ³ /s	sccm	Torr l/s	atm cm ³ /s
mbar l/s	1	0.1	59.2	0.75	0.987
Pa m ³ /s	10	1	592	7.5	9.87
sccm	$1.69 \cdot 10^{-2}$	$1.69 \cdot 10^{-3}$	1	$1.27 \cdot 10^{-2}$	$1.67 \cdot 10^{-2}$
Torr l/s	1.33	0.133	78.9	1	1.32
atm cm ³ /s	1.01	0.101	59.8	0.76	1

Tbl. 43: Gas throughputs and their conversion





Intertek
4010094

ETL LISTED

The products CenterOne, CenterTwo and CenterThree

- conform to the UL standards

UL 61010-1 and UL 61010-2-030.

- are certified to the CAN/CSA standards

CAN/CSA C22.2 No. 61010-1 and CANCSA C22.2 No. 61010-2-030.



Declaration of conformity

We hereby declare that the product cited below satisfies all relevant provisions of the following **EU Directives**:

- **Low voltage 2014/35/EC**
- **Electromagnetic compatibility 2014/30/EU**
- **Restriction of the use of certain hazardous substances 2011/65/EU**

Total pressure measuring and control unit
CenterOne, CenterTwo, CenterThree

Harmonized standards and applied national standards and specifications:

DIN EN 61000-3-2:2015-03
DIN EN 61000-3-3:2014-03
DIN EN 61000-6-1:2007-10
DIN EN 61000-6-2:2006-03
DIN EN 61000-6-3:2011-09
DIN EN 61000-6-4:2011-09
DIN EN 61010-1:2011-07
DIN EN 61326-1:2013-07
RoHS (fully compliant)

Signature:



(Dr. Ulrich von Hülsen)
Managing Director

Pfeiffer Vacuum GmbH
Berliner Straße 43
35614 Aßlar
Germany

Aßlar, 2018-04-16



VACUUM SOLUTIONS FROM A SINGLE SOURCE

Pfeiffer Vacuum stands for innovative and custom vacuum solutions worldwide, technological perfection, competent advice and reliable service.

COMPLETE RANGE OF PRODUCTS

From a single component to complex systems:

We are the only supplier of vacuum technology that provides a complete product portfolio.

COMPETENCE IN THEORY AND PRACTICE

Benefit from our know-how and our portfolio of training opportunities!

We support you with your plant layout and provide first-class on-site service worldwide.

ed. B - Date 1908 - P/N:BG5044BEN



Are you looking for a
perfect vacuum solution?
Please contact us

Pfeiffer Vacuum GmbH
Headquarters • Germany
T +49 6441 802-0
info@pfeiffer-vacuum.de

www.pfeiffer-vacuum.com

PFEIFFER  **VACUUM**

